

# Billing Boats®



## Zeeland 428\*\*

PHOTO MANUAL



## DK ZEELAND

"WINSTON CHURCHILL", senere kaldet "ZEELAND", blev bygget under Anden Verdenskrig og udstyret med en dampmaskine. Det var faktisk den sidste dampdrevne slæbebåd til kystbrug bygget for det hollandske firma Goedkoop i Amsterdam. Fartøjet blev senere solgt til det hollandske firma Willem Muller i Terneuzen i 1964, hvor hun blev udstyret med en dieselmotor og omdøbt til "ZEELAND Hun blev brudt op i". 1997 i Dordrecht, Holland, siger en af skibets kaptajner, Henk de Winde, "Hun var en svær dame at omgås, men efter 25 års lykkeligt ægteskab ved jeg, at hun var meget speciel, og jeg er stadig ikke sikker., hvilken af os var bedst."

## GB ZEELAND

The "WINSTON CHURCHILL", later called the "ZEELAND" was built during the Second World War and equipped with a steam engine. It was, in fact, the last steam-driven tug for coastal use built for the Dutch company Goedkoop in Amsterdam. The vessel was later sold to the Dutch company Willem Muller in Terneuzen in 1964, where she was equipped with a diesel engine and renamed the "ZEELAND". She was broken up in 1997 in Dordrecht, Holland. Says one of the ship's captains, Henk de Winde, "She was a difficult lady to get along with, but after 25 years of happy marriage, I know that she was very special, and I am still not sure, which one of us was best."

## D ZEELAND

"WINSTON CHURCHILL", später "ZEELAND", wurde während des zweiten Weltkriegs gebaut und mit einer Dampfmaschine ausgerüstet. Das für Küstengewässer bestimmte Schiff war der letzte Dampfschlepper, der bei der niederländischen Firma Goedkoop in Amsterdam gebaut wurde. Das Schiff wurde später an die niederländische Firma Willem Muller in Terneuzen verkauft, erhielt einen Dieselmotor, wurde 1964 in "ZEELAND" umgetauft und 1997 in Dordrecht, Holland, abgewrackt. Einer ihrer Kapitäne, Henk de Winde, sagt: "Sie war eine schwierige Dame, aber nach 25 jähriger, glücklicher Ehe weiß ich, daß sie etwas Besonderes war, und ich weiß noch immer nicht, wer am besten war."

## F ZEELAND

Le « WINSTON CHURCHILL », plus tard appelé « ZEELAND », a été construit pendant la Seconde Guerre mondiale et équipé d'un moteur à vapeur. Il s'agissait en fait du dernier remorqueur côtier à vapeur construit pour la société néerlandaise Goedkoop à Amsterdam. Le navire a ensuite été vendu à la société néerlandaise Willem Muller à Terneuzen en 1964, où il a été équipé d'un moteur diesel et rebaptisé « ZEELAND ». Il a été démantelé en 1997 à Dordrecht, aux Pays-Bas. L'un des capitaines du navire, Henk de Winde, a déclaré : « C'était une femme difficile à vivre, mais après 25 ans de mariage heureux, je sais qu'elle était très spéciale, et je ne sais toujours pas lequel d'entre nous était le meilleur. »

## NL ZEELAND

Het schip werd tijdens de laatste wereldoorlog als stoomsleepboot gebouwd voor Rederij Goedkoop in Amsterdam en voer onder de naam "Winston Churchill" in de Nederlandse kustwateren. In 1964 werd het schip verkocht aan Rederij Willem Muller in Terneuzen, omgebouwd naar diesel aandrijving en omgedoopt tot "Zeeland". In 1997 werd het schip in Dordrecht gesloopt. Eén van haar kapiteins, Henk de Winde, zegt: "Ze was een lastige dame in de omgang, speciaal bij zijwind, maar ze had ook haar goede kanten".

## E ZEELAND

El "WINSTON CHURCHILL", más tarde llamado "ZEELAND", fue construido durante la Segunda Guerra Mundial y equipado con un motor de vapor. De hecho, fue el último remolcador a vapor para uso costero construido para la compañía holandesa Goedkoop en Ámsterdam. El barco fue vendido más tarde a la compañía holandesa Willem Muller en Terneuzen en 1964, donde fue equipado con un motor diésel y rebautizado como "ZEELAND". Fue desguazado en 1997 en Dordrecht, Holanda. Uno de los capitanes del barco, Henk de Winde, dice: "Era una mujer con la que era difícil llevarse bien, pero después de 25 años de feliz matrimonio, sé que era muy especial y todavía no estoy seguro de cuál de los dos era el mejor".

## I ZEELAND

Il "WINSTON CHURCHILL", in seguito chiamato "ZEELAND", fu costruito durante la seconda guerra mondiale e dotato di un motore a vapore. Fu, infatti, l'ultimo rimorchiatore a vapore per uso costiero costruito per la compagnia olandese Goedkoop di Amsterdam. La nave fu poi venduta alla compagnia olandese Willem Muller di Terneuzen nel 1964, dove fu dotata di un motore diesel e ribattezzata "ZEELAND". Fu demolita nel 1997 a Dordrecht, in Olanda. Dice uno dei capitani della nave, Henk de Winde, "Era una donna difficile con cui andare d'accordo, ma dopo 25 anni di felice matrimonio, so che era molto speciale, e non sono ancora sicuro di chi di noi due fosse il migliore".

## P ZEELAND

O "WINSTON CHURCHILL", mais tarde denominado "ZEELAND" foi construído durante a Segunda Guerra Mundial e equipado com uma máquina a vapor. Foi, de facto, o último rebocador a vapor para uso costeiro construído para a empresa holandesa Goedkoop em Amsterdão. O navio foi posteriormente vendido à empresa holandesa Willem Muller em Terneuzen em 1964, onde foi equipado com um motor diesel e renomeado "ZEELAND". que ela era muito especial e ainda não tenho a certeza de qual de nós era a melhor."

## PL ZEELAND

„WINSTON CHURCHILL“; później nazwany „ZEELAND“, został zbudowany podczas II wojny światowej i wyposażony w maszynę parową. Był to w rzeczywistości ostatni holownik parowy do użytku przybrzeżnego zbudowany dla holenderskiej firmy Goedkoop w Amsterdamie. Statek został później sprzedany holenderskiej firmie Willem Muller w Terneuzen w 1964 roku, gdzie został wyposażony w silnik diesla i przemianowany na „ZEELAND“. Został złomowany w 1997 roku w Dordrecht w Holandii. Jeden z kapitanów statku, Henk de Winde, mówi: „Była trudną kobietą we wspólnocie, ale po 25 latach szczęśliwego małżeństwa wiem, że była bardzo wyjątkowa i nadal nie jestem pewien, która z nas była najlepsza“.

### To see our color conversion chart please visit <https://www.billingboats.com/faq>

Til denne model er mahogni bejse og farver med følgende numre nødvendige:

For this model is mahogany stain and colours with the following numbers should be used:

Für dieses Modell sind Mahagoni Beize und Farben mit den folgenden Nummern notwendig:

Pour ce modèle, le mordant et les couleurs avec les numéros suivants doivent être employés:

Voor dit model zijn kleuren met de volgende nummers nodig:















Para est modelo se necesitan mordiente et colores con los siguientes números:

Per questo modello occorrono inchiostro tinteggiatore "mogano" e colori con questi numeri:

Pinte o modelo com tintura cor Mogno e as cores sugeridas da Billing Boats:

W przypadku tego modelu należy użyć bejcy mahoniowej oraz farby o numerach:

Billing 1	= White	Billing 18	=Mediterranean Blue
Billing 4	= Orange	Billing 35	=Signal Red
Billing 5	=Tan	Billing 36	=Mahogany Stain
Billing 6	=Hull Red		
Billing 7	=Sea Blue		
Billing 8	=Brunswick Green		
Billing 11	= Black		
Billing 12	= Pale Grey		
Billing 13	=Trainer Yellow		
Billing 15	=Silver		
Billing 17	=Clear Poly		

	Part number	<input type="text" value="XXmm - length"/>		Cut out		Paint with primer paint
	Paint number (* alternative colour)			Use putty (fill and sand)		Use cyanoacrylate glue
	Wood stain			Fit to other parts		Give shape (before sticking)
	Rope number			Part made with layers		Give shape (before sticking, if necessary use water)
	Give shape (for example use sand paper)			Drill a hole (x mm)		Roll up

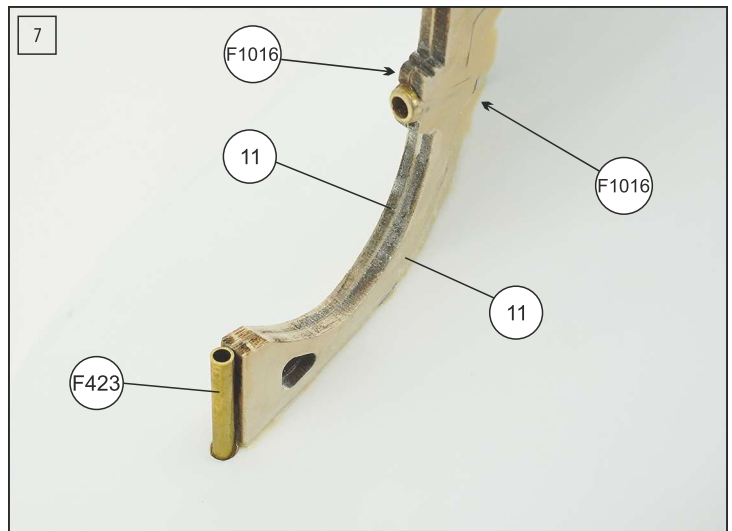
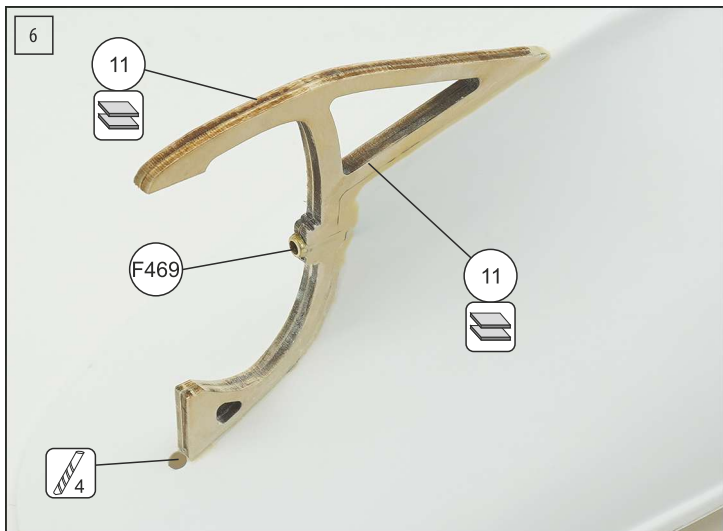
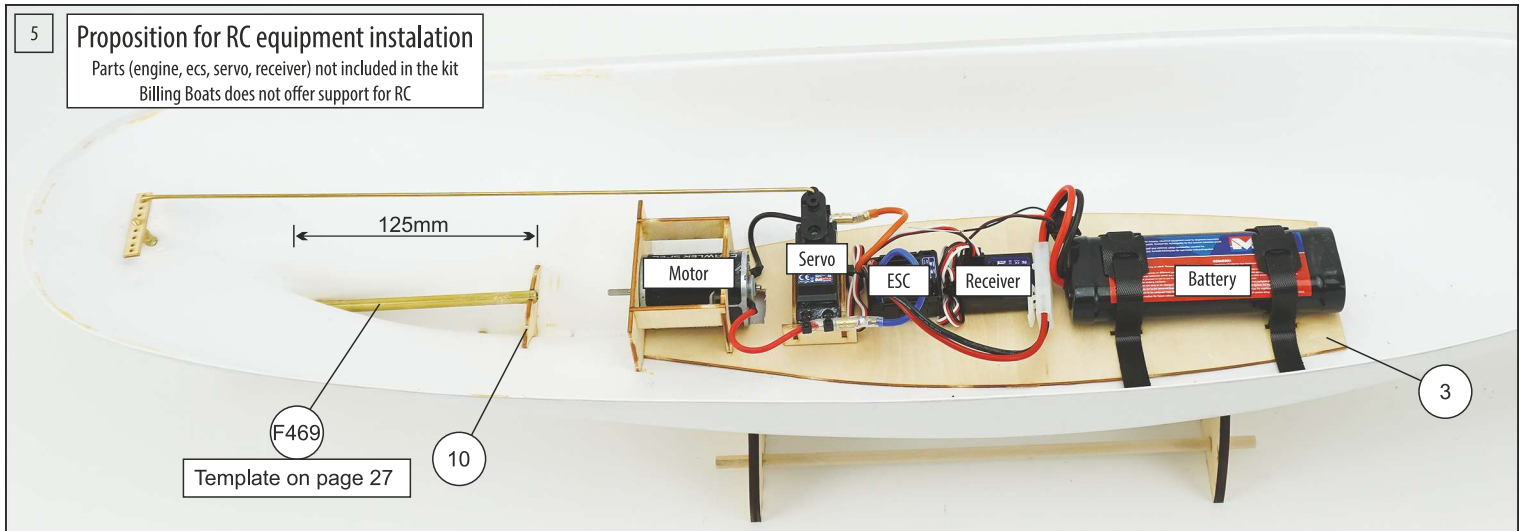
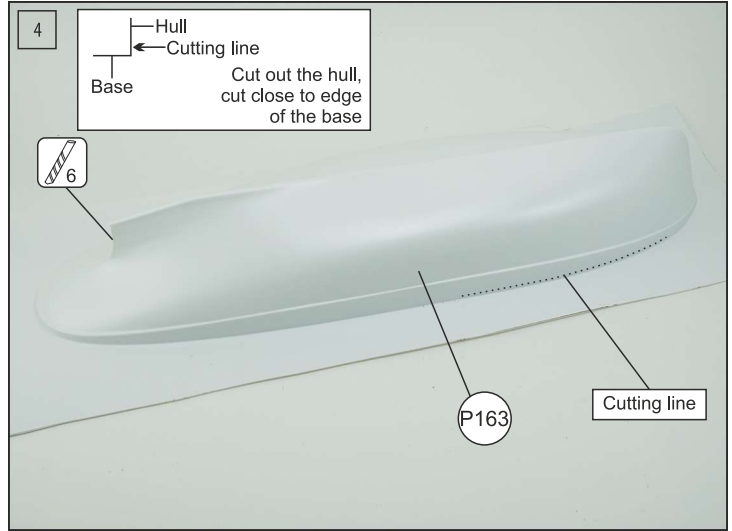
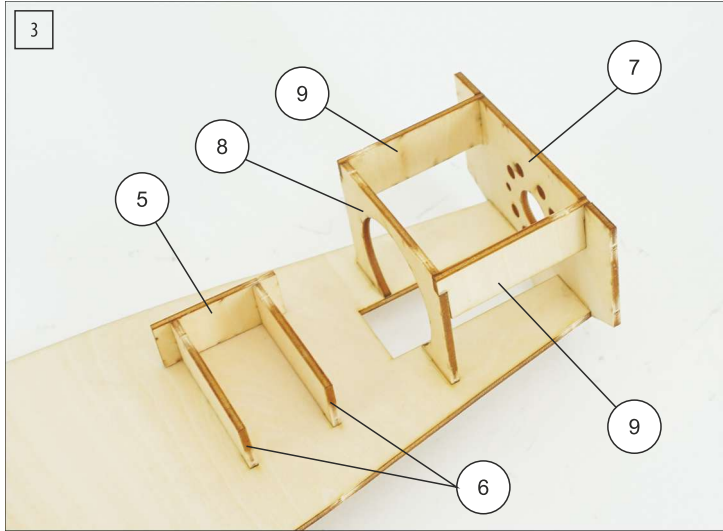
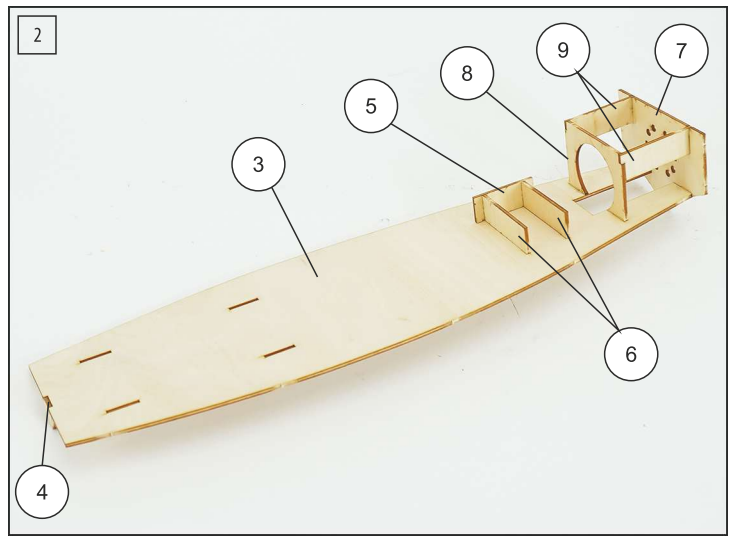
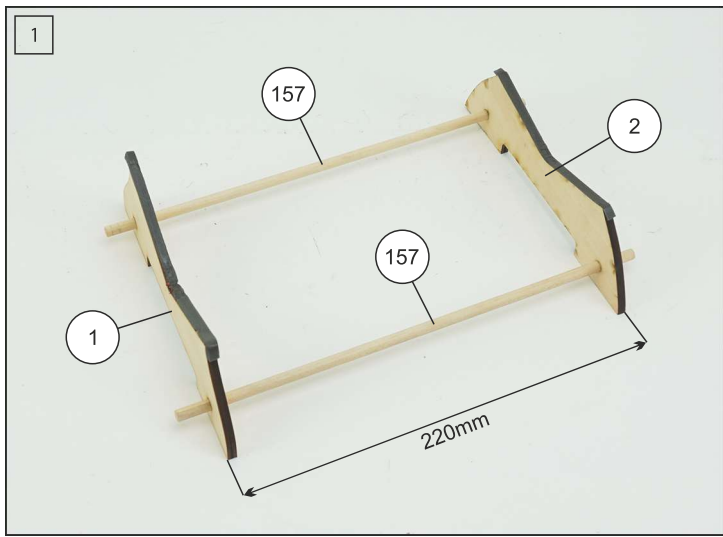



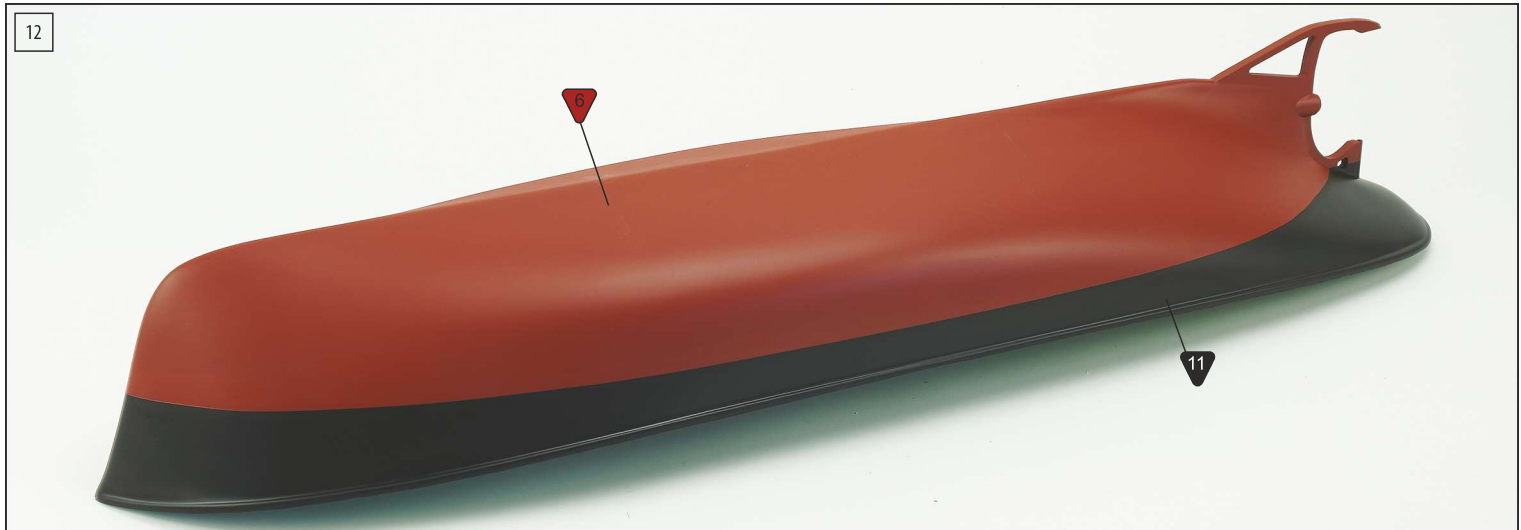
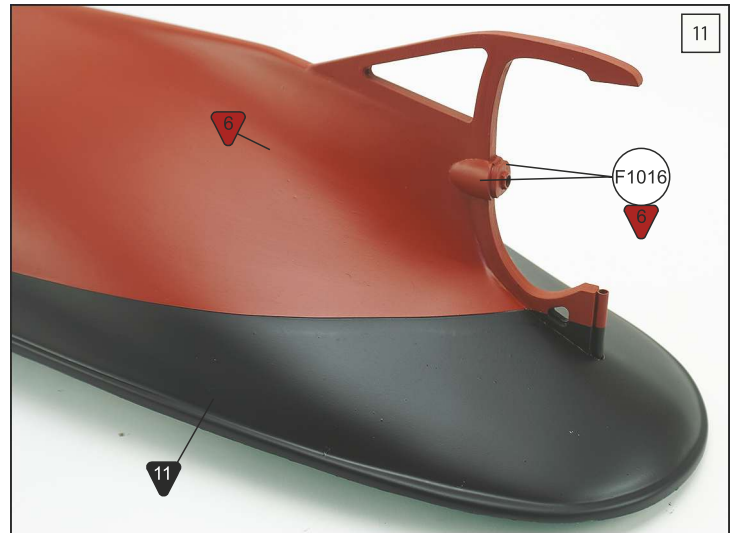
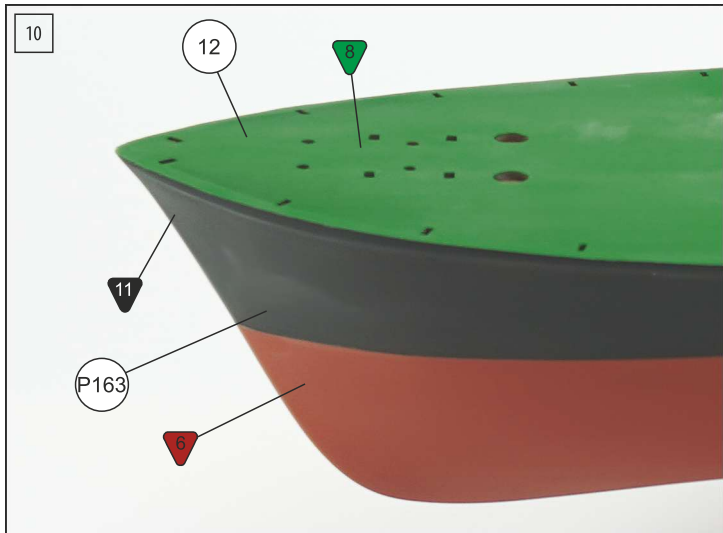
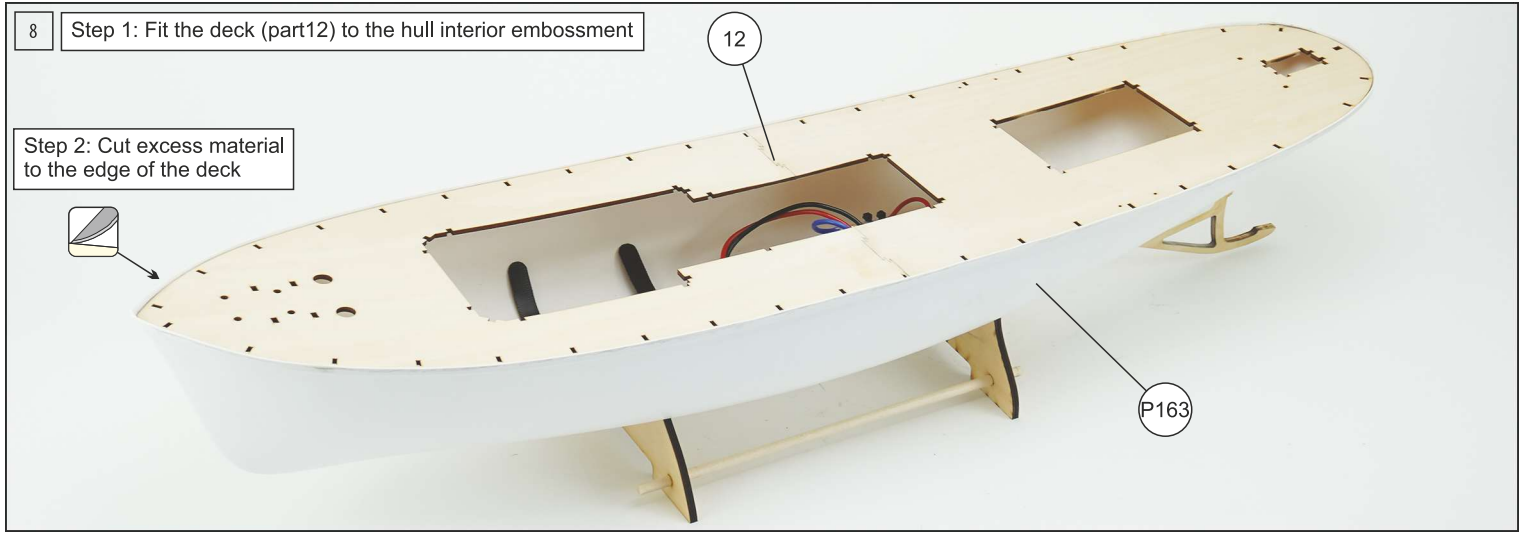





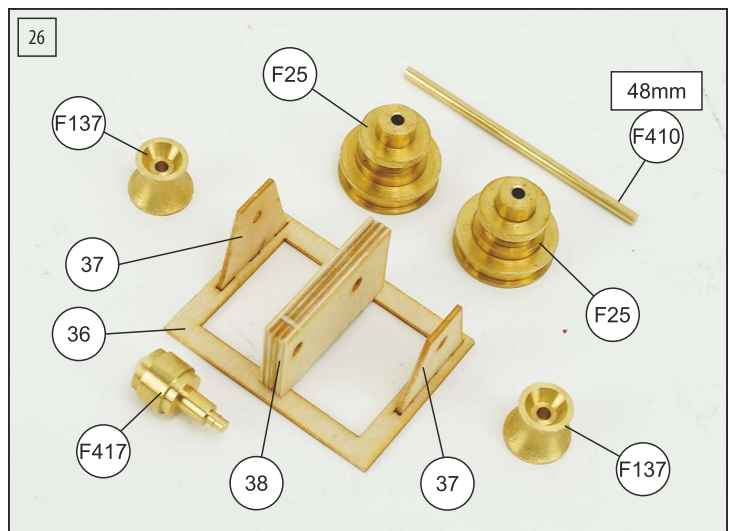
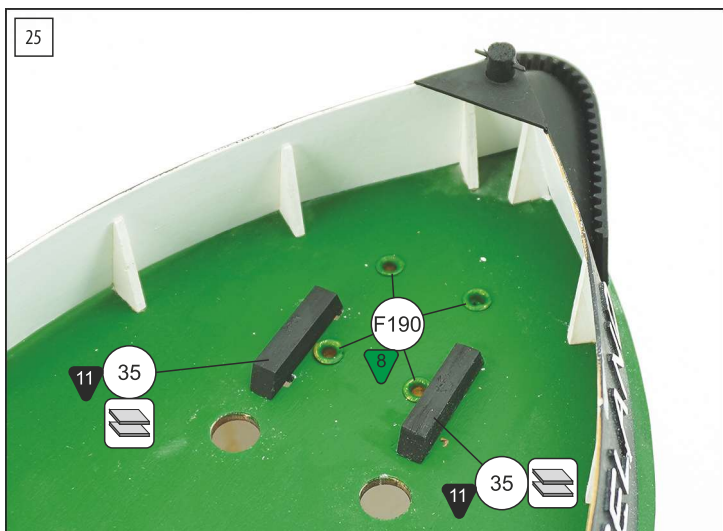
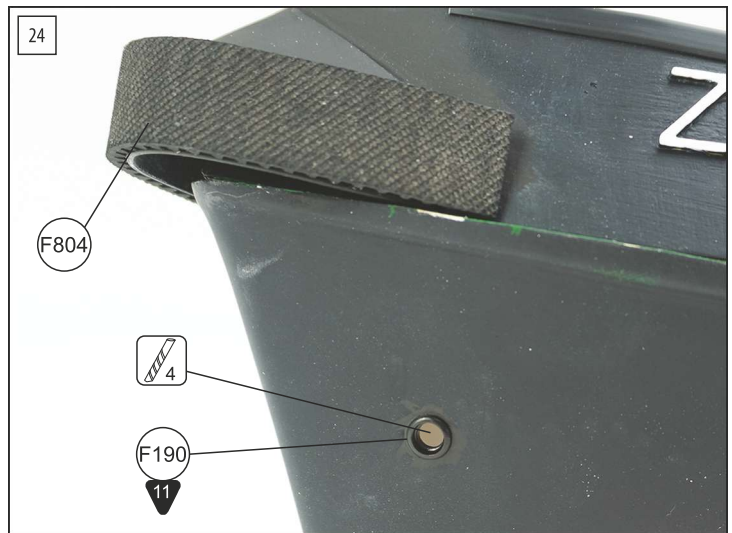
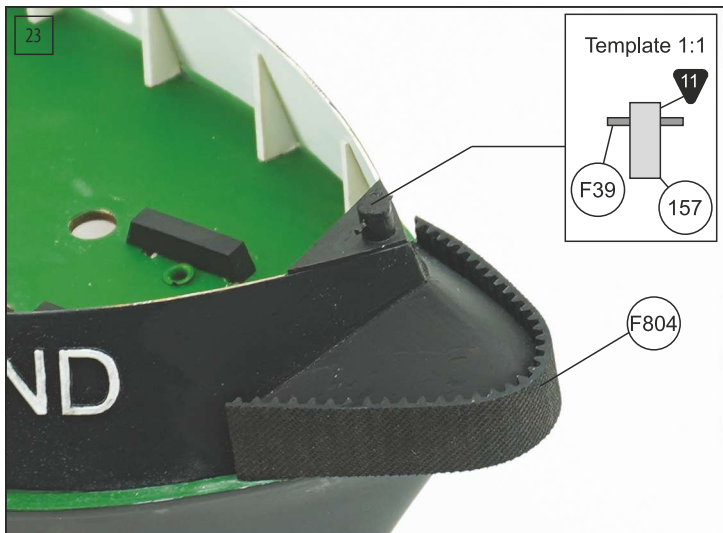
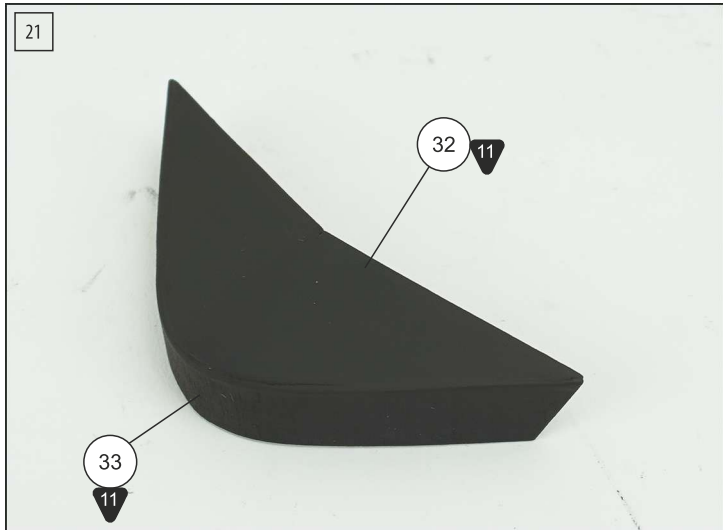
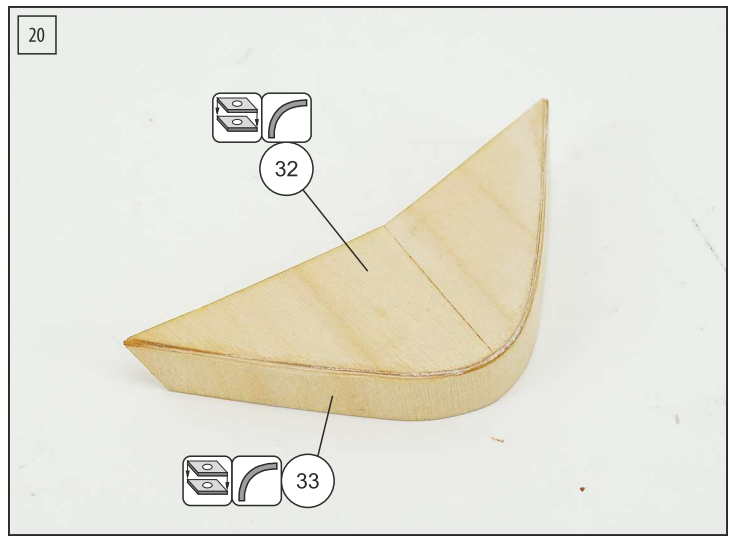
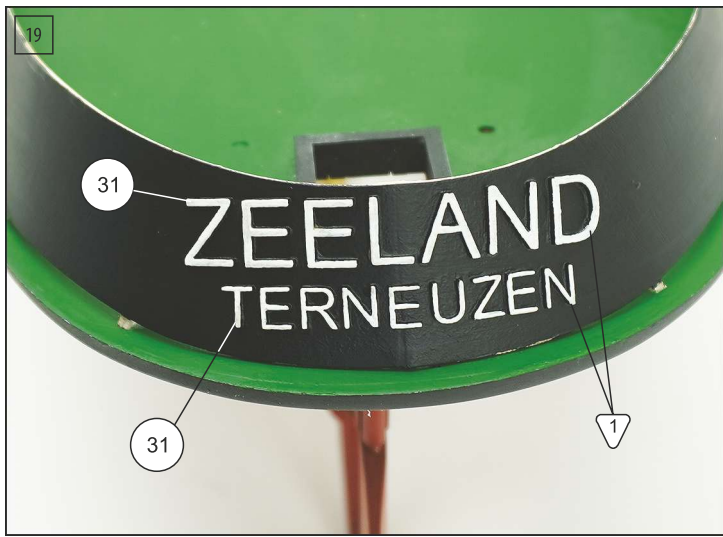



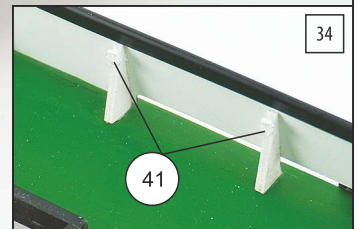
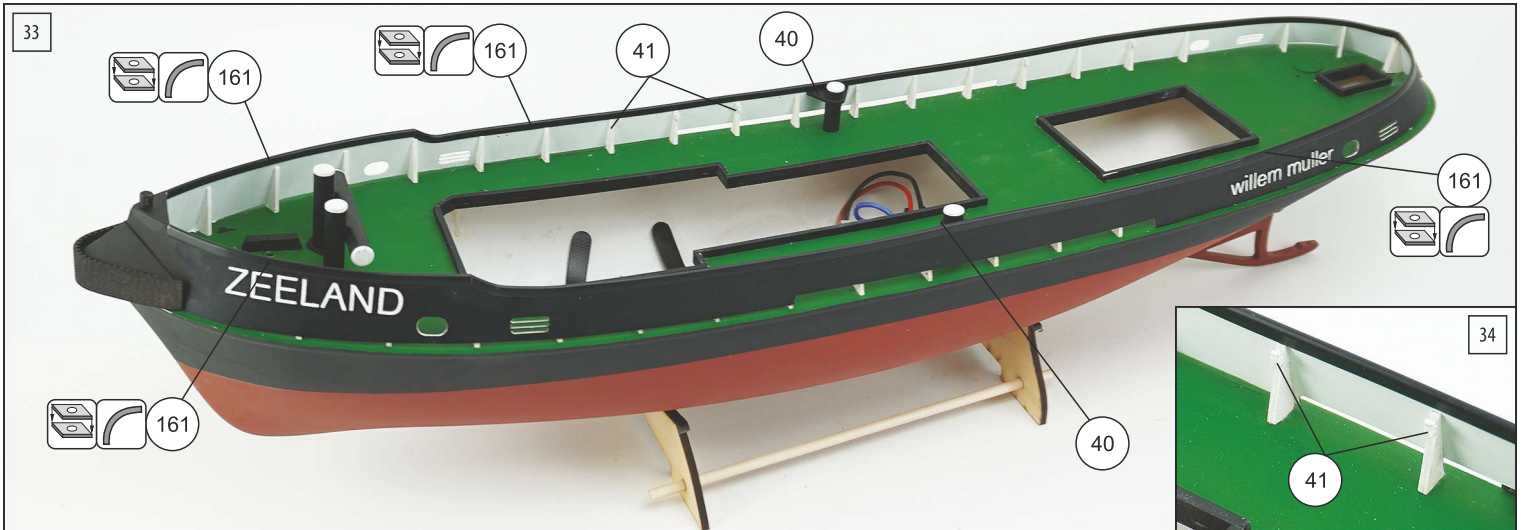
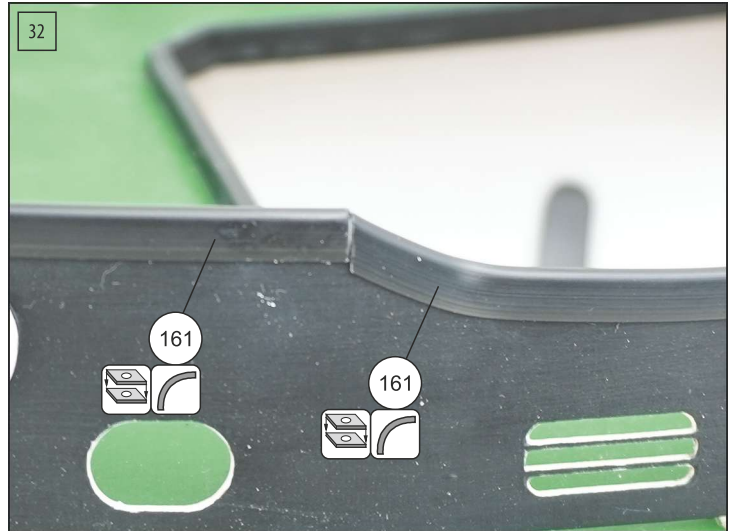
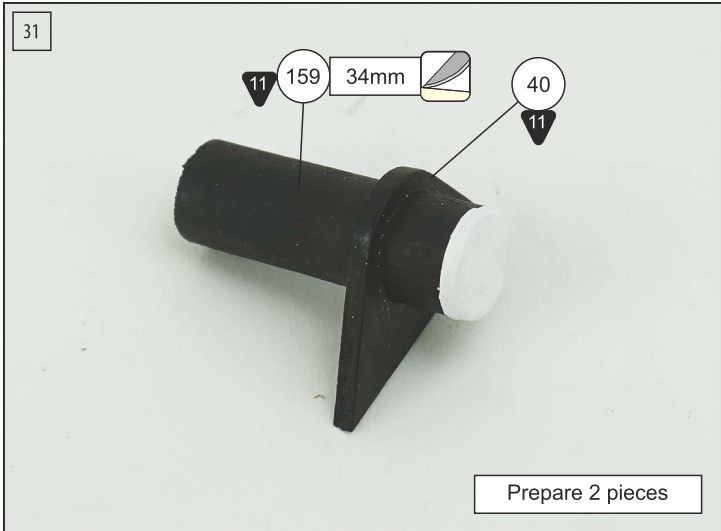
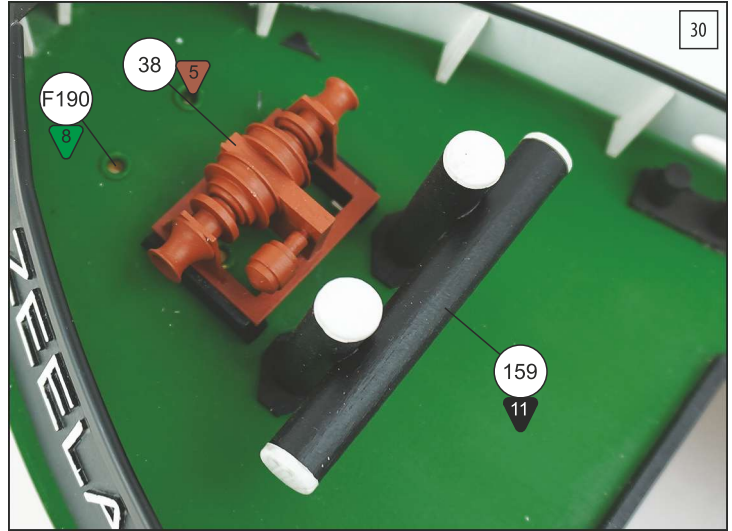
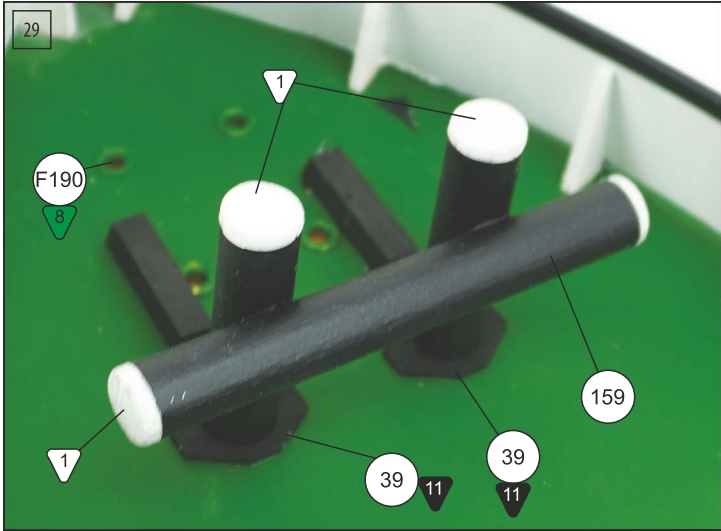
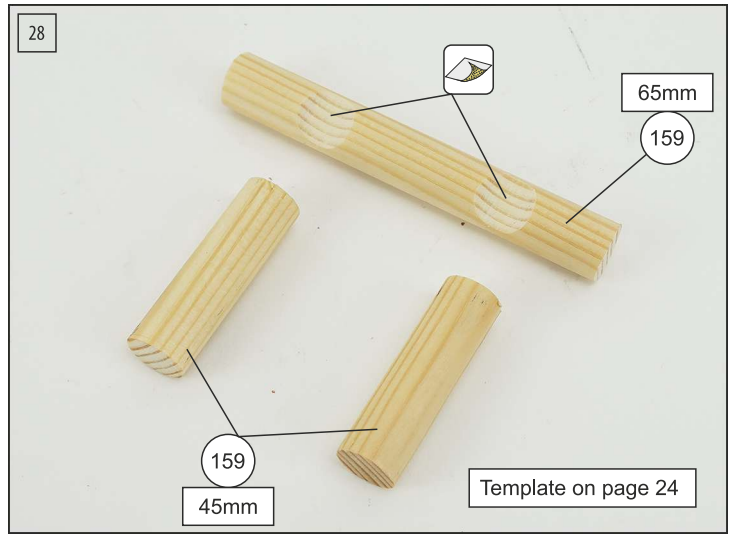



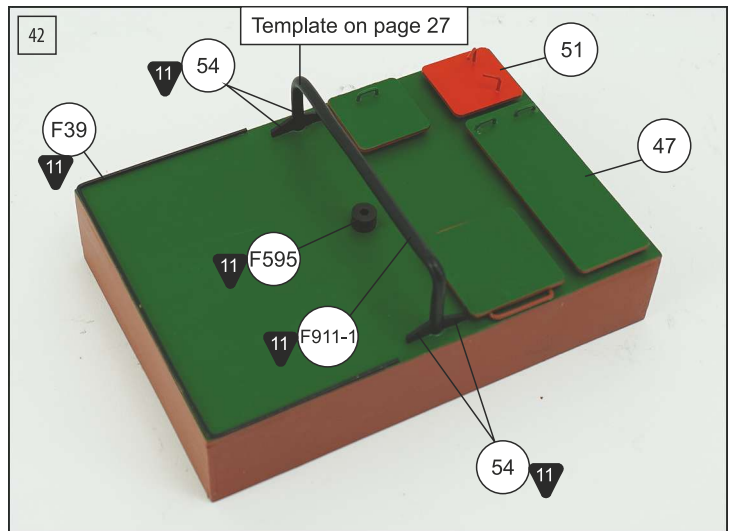
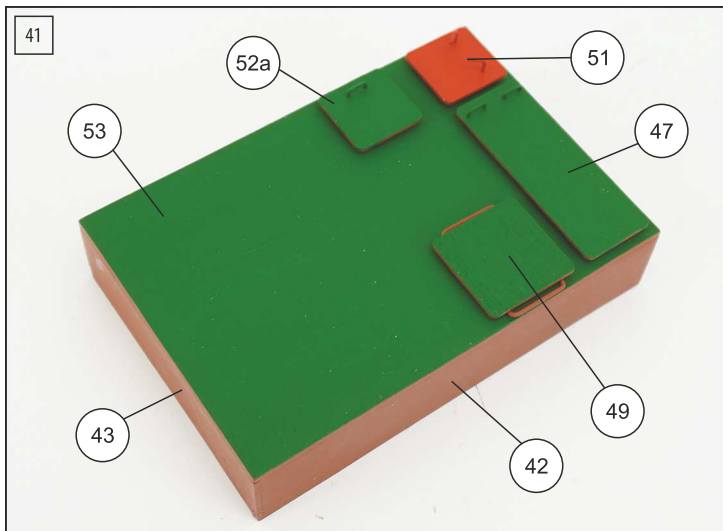
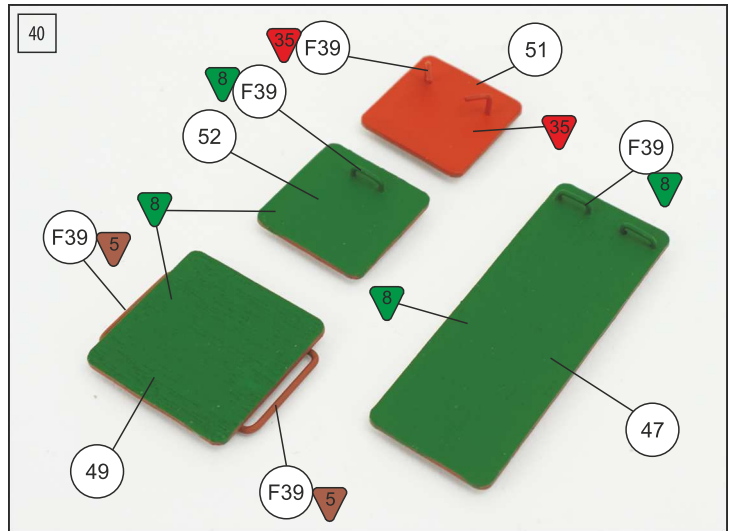
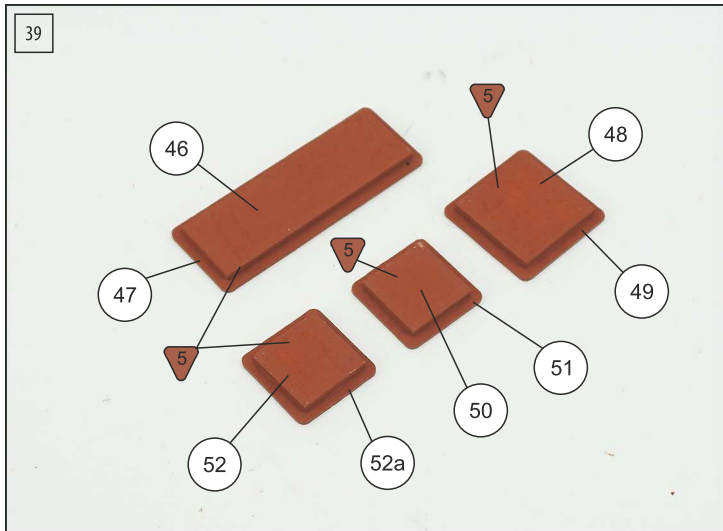
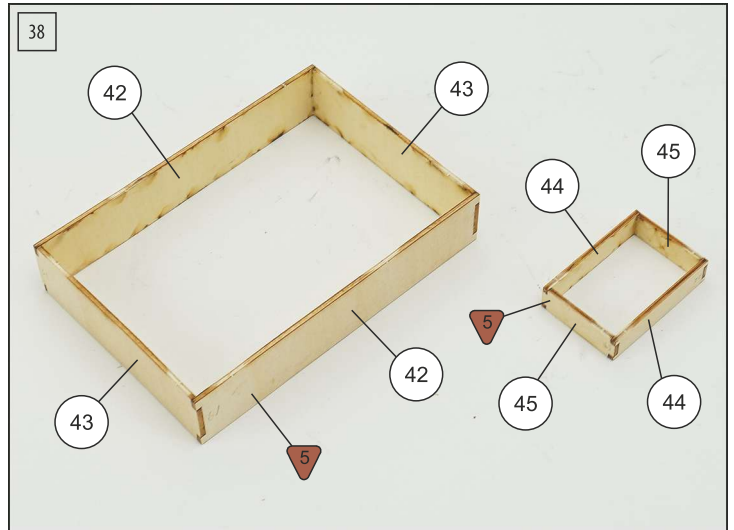
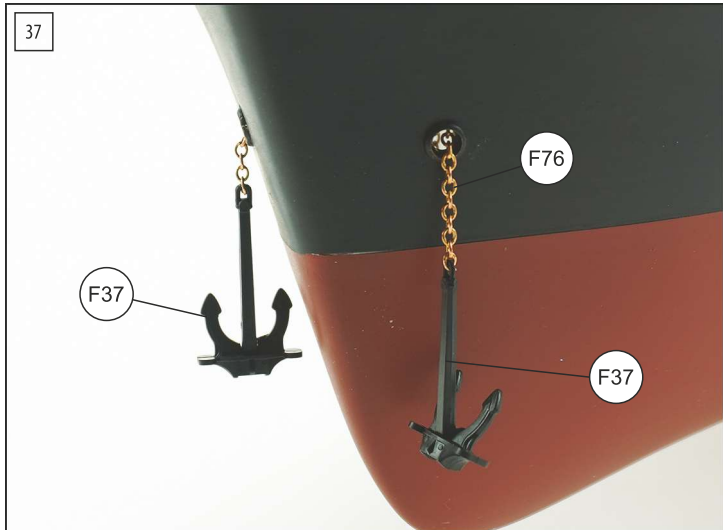
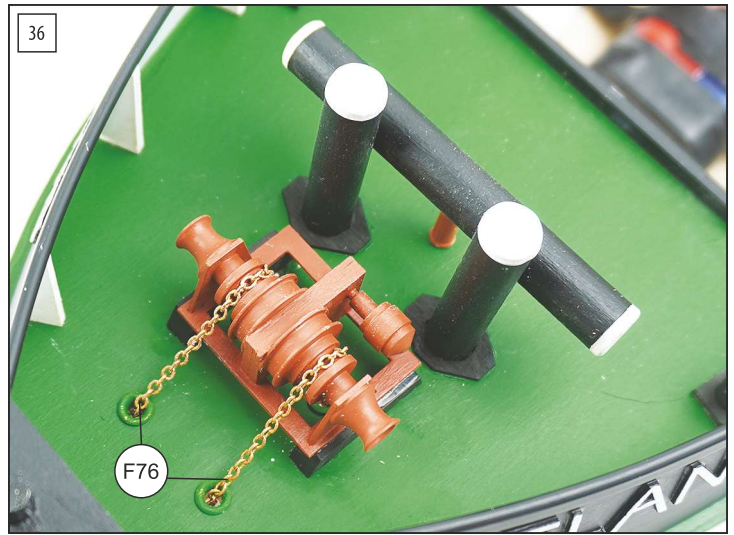

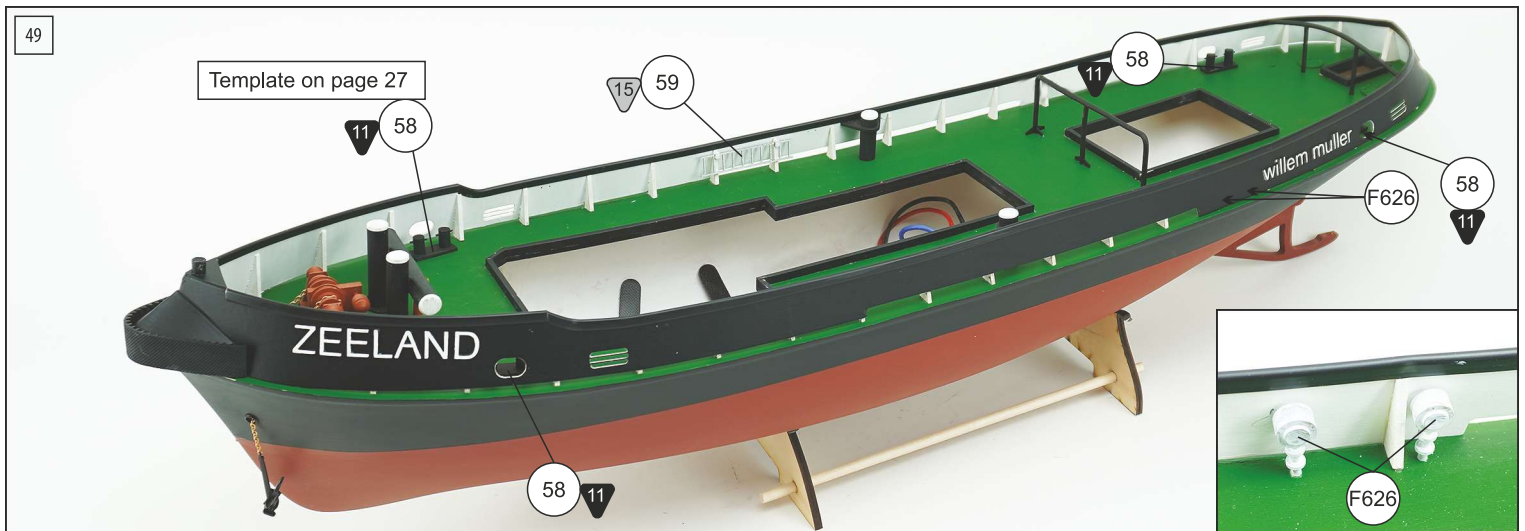
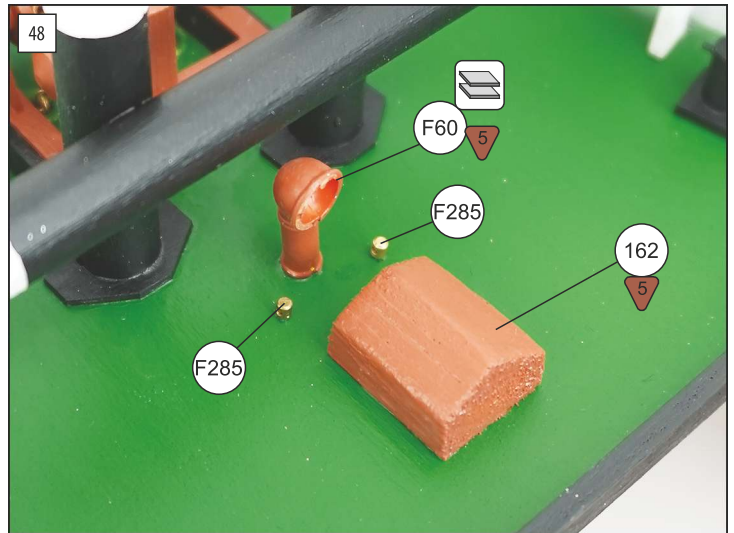
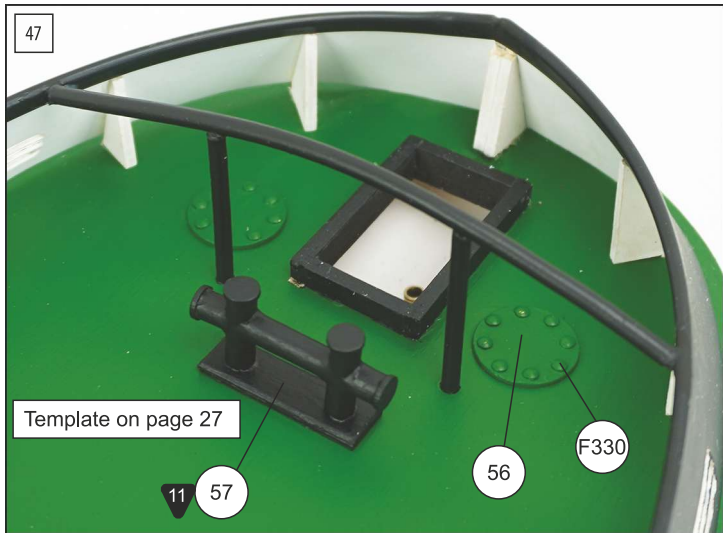
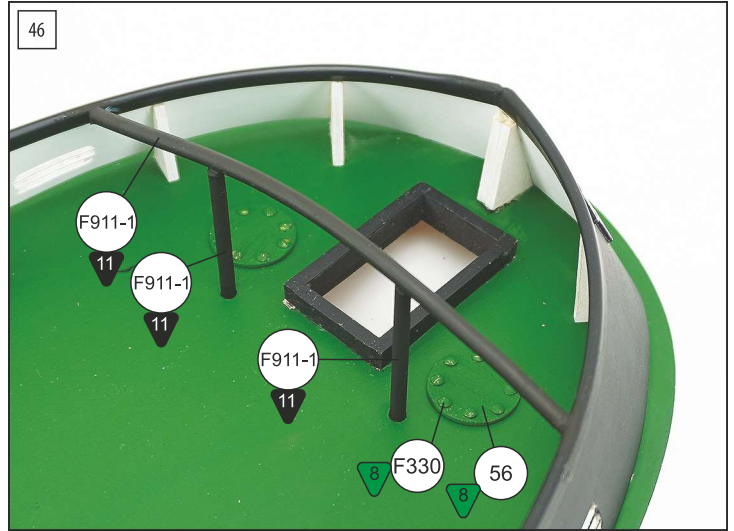
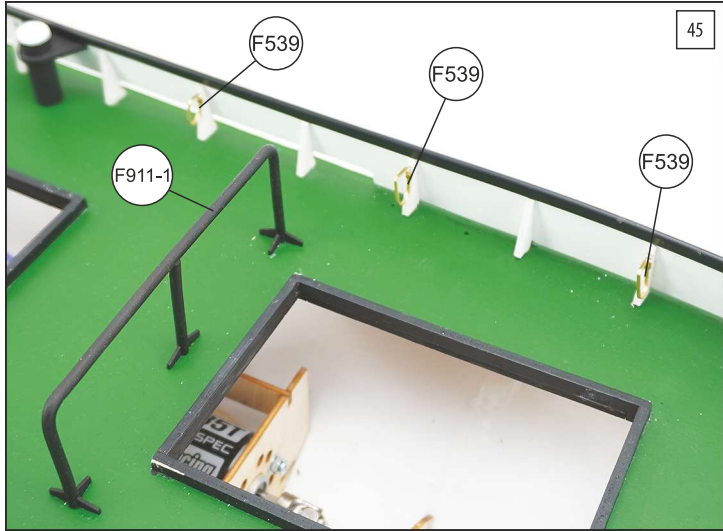
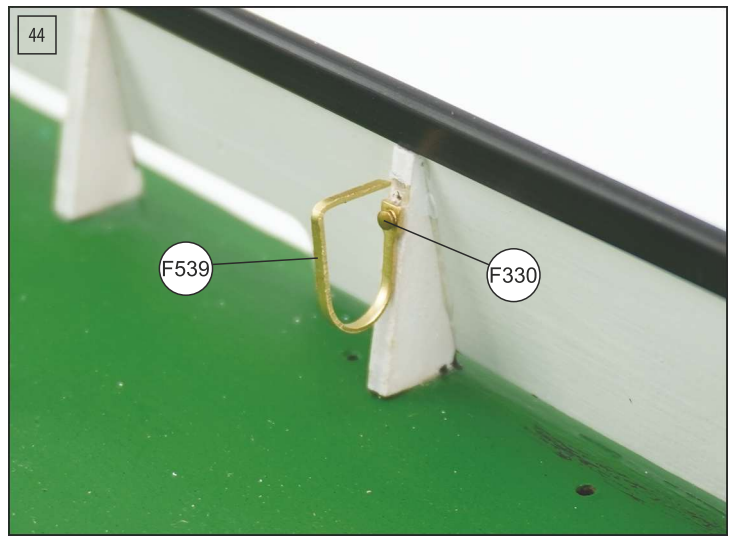
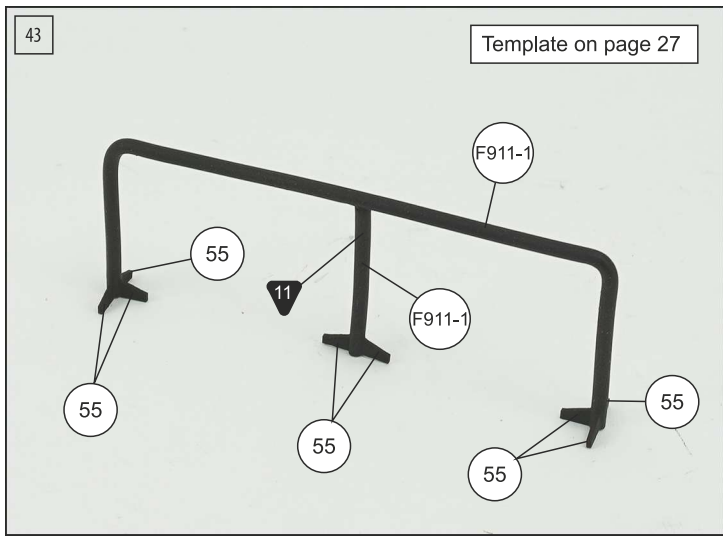



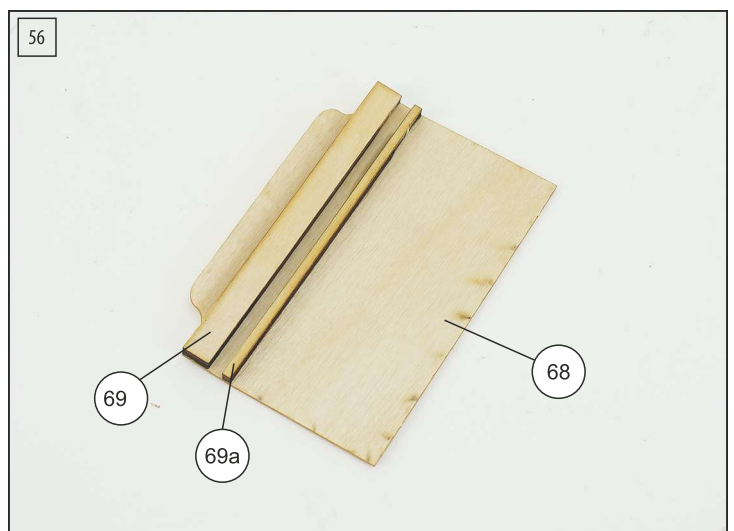
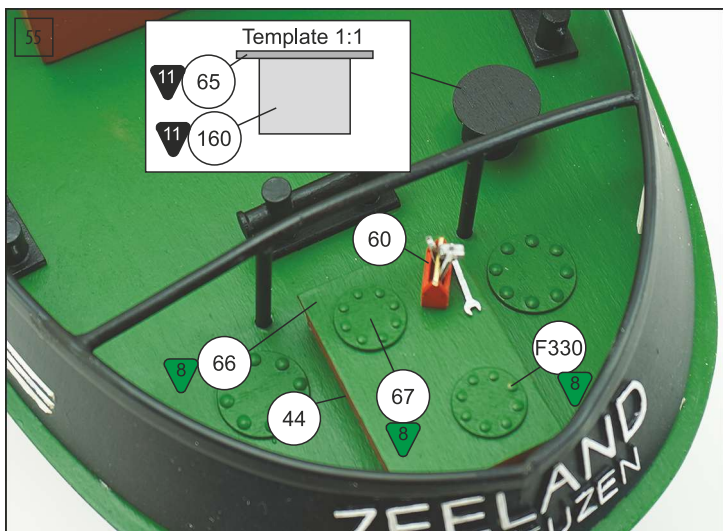
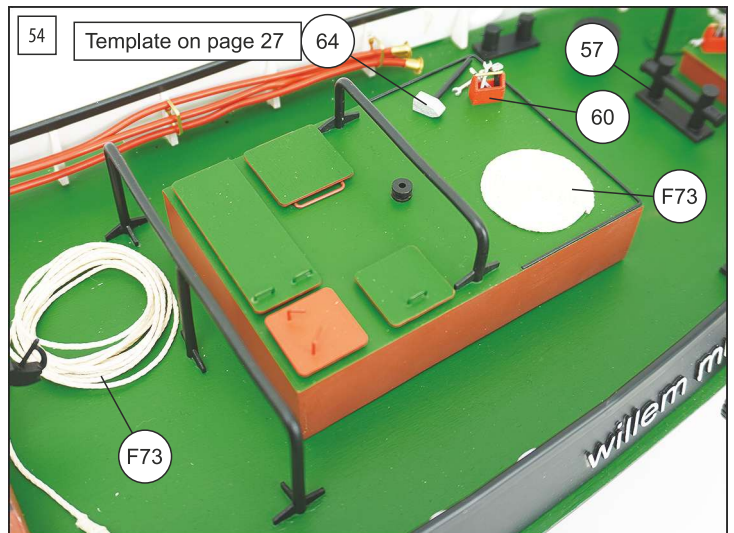
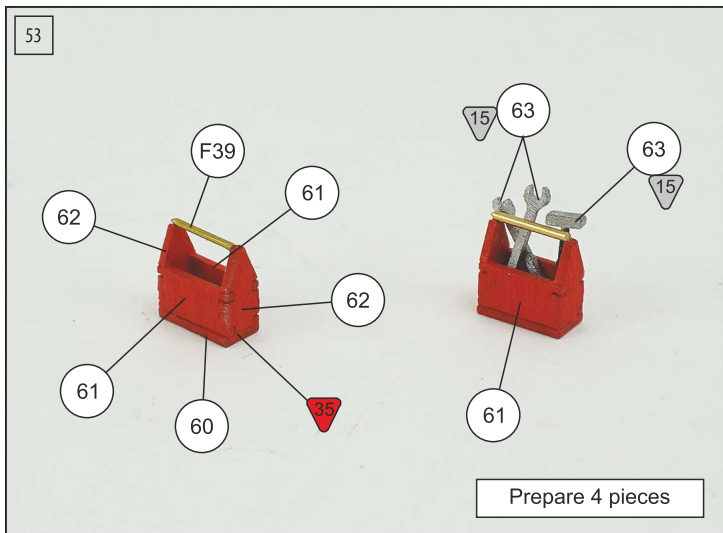
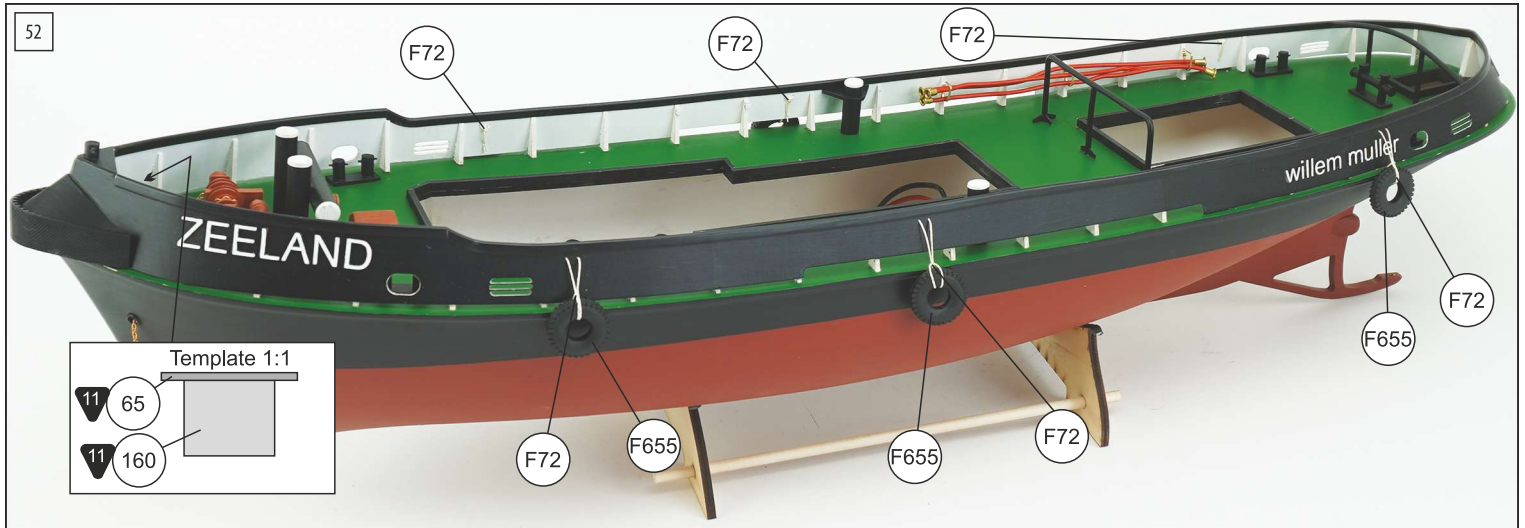
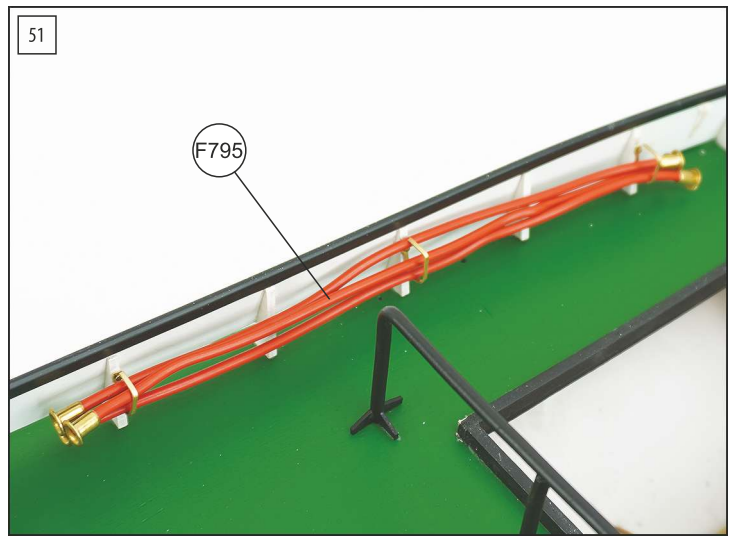
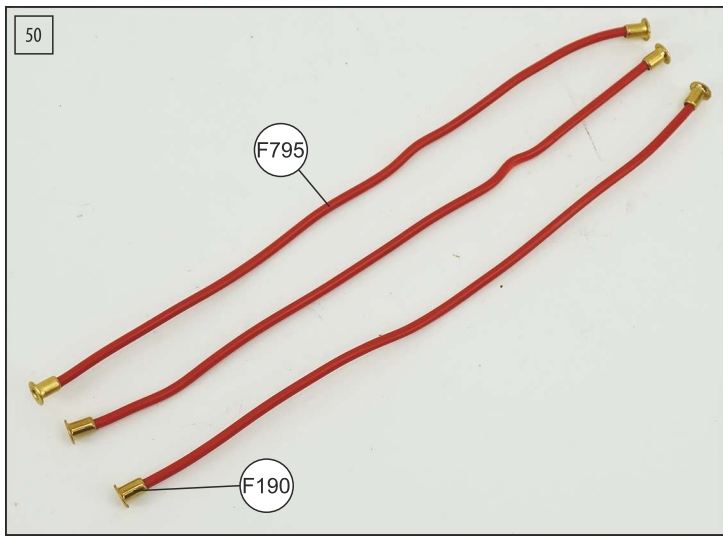



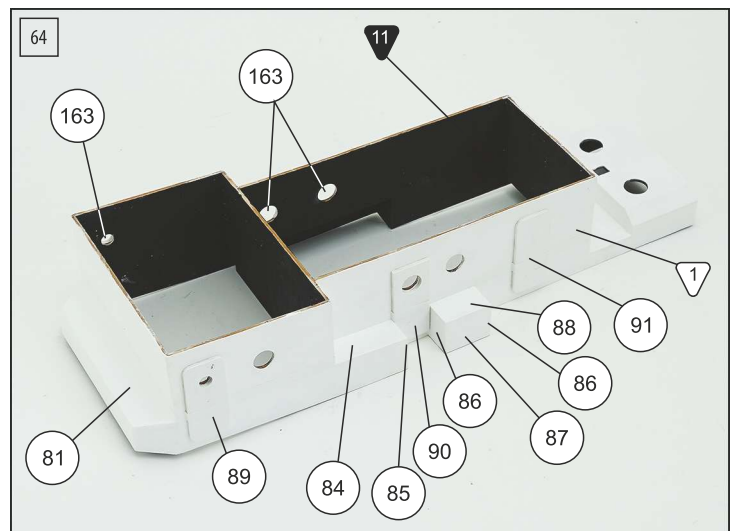
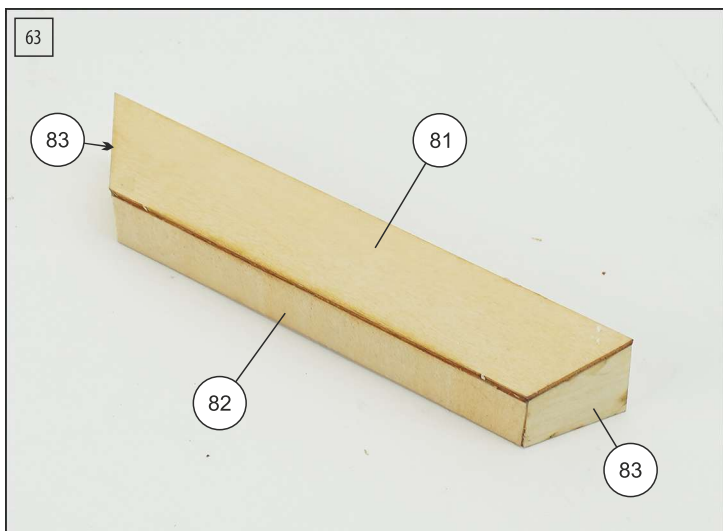
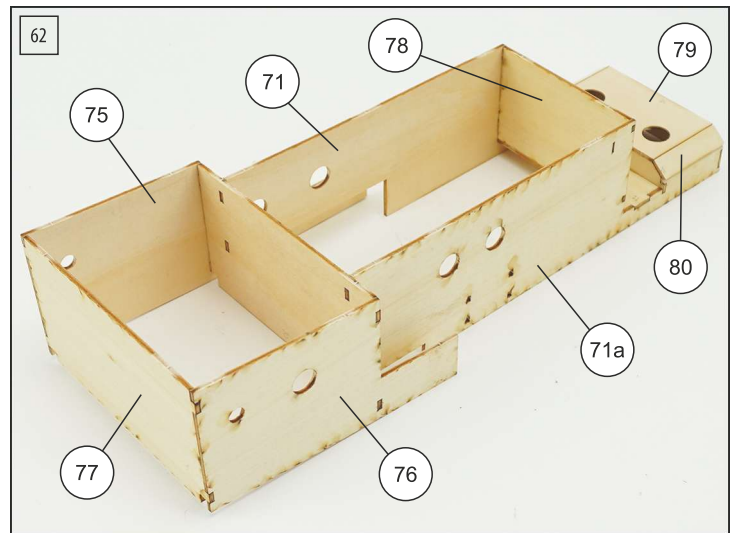
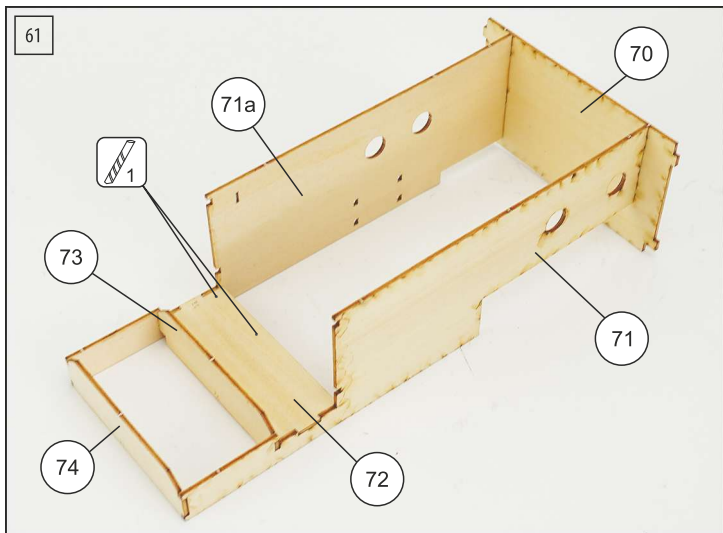
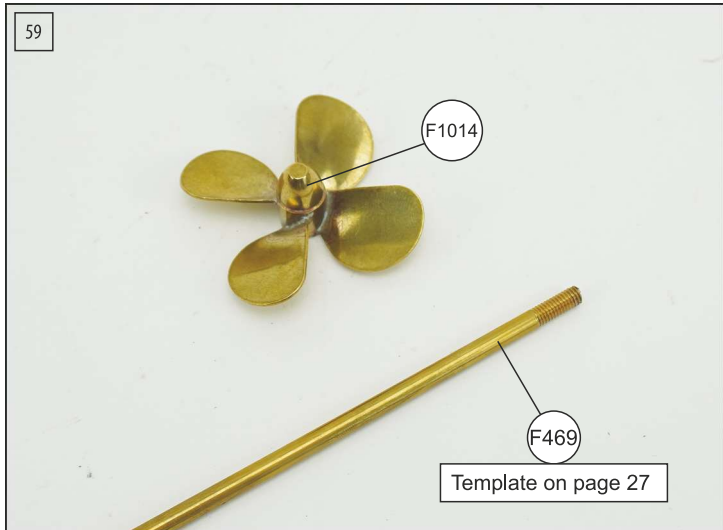
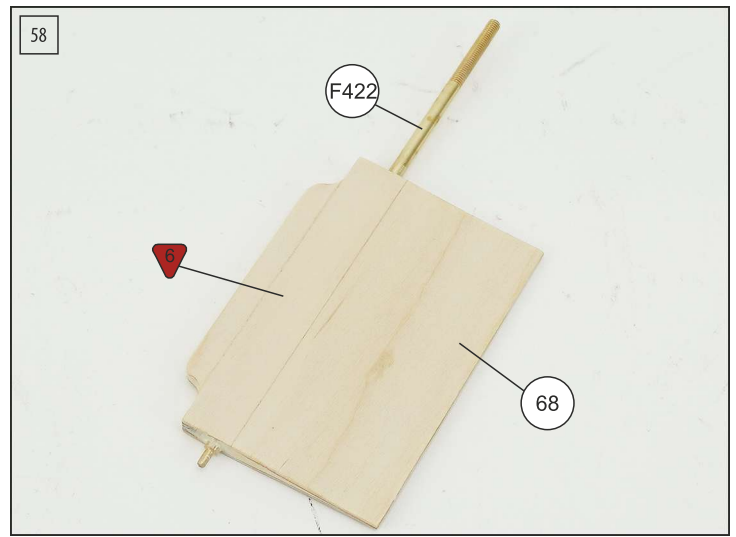
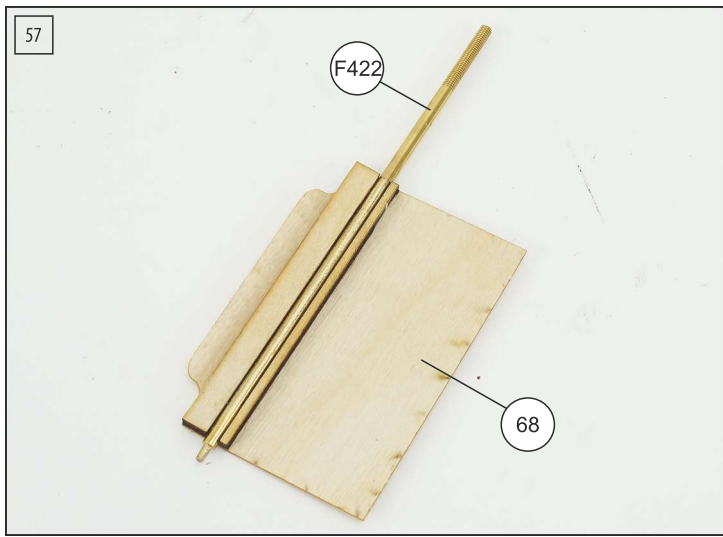

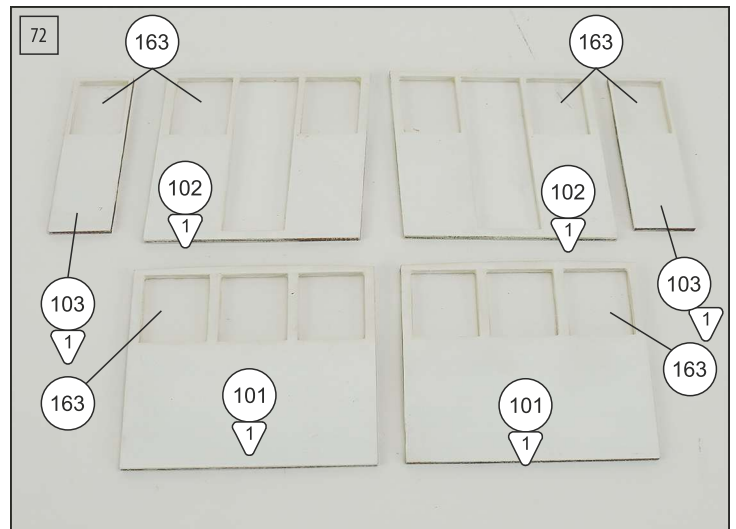
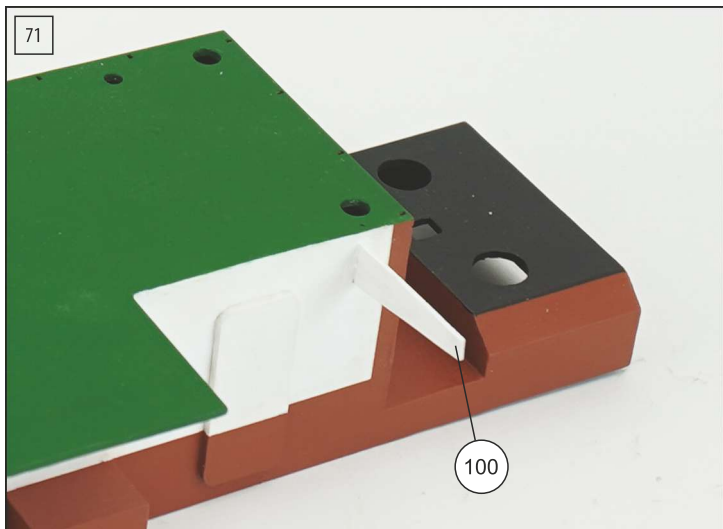
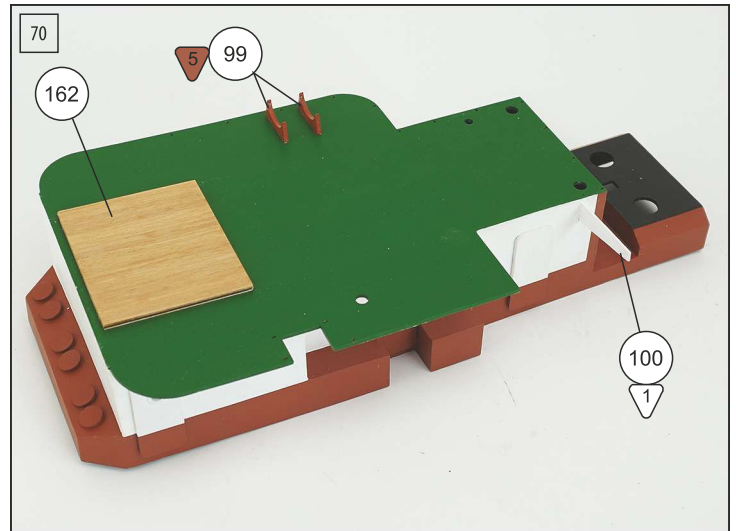
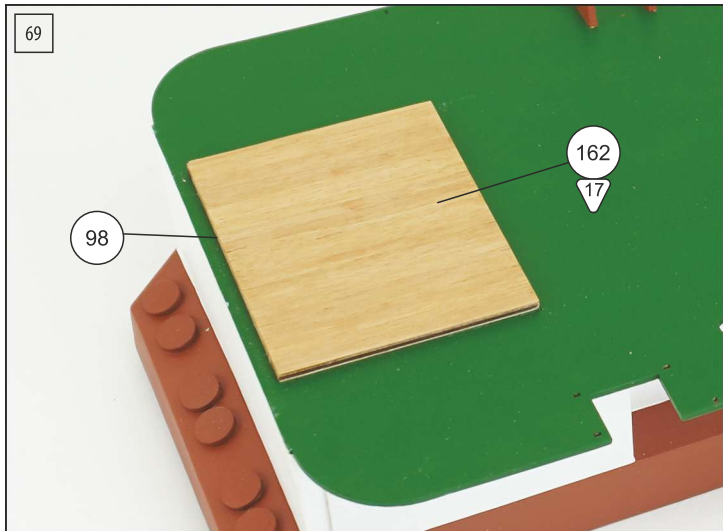
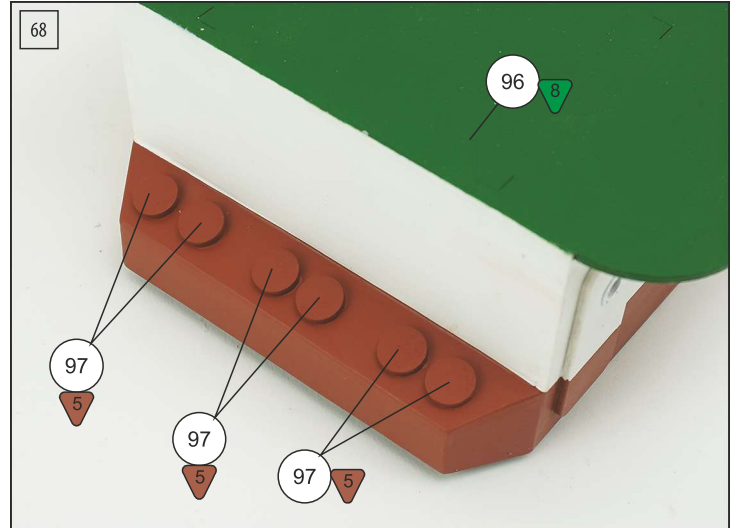
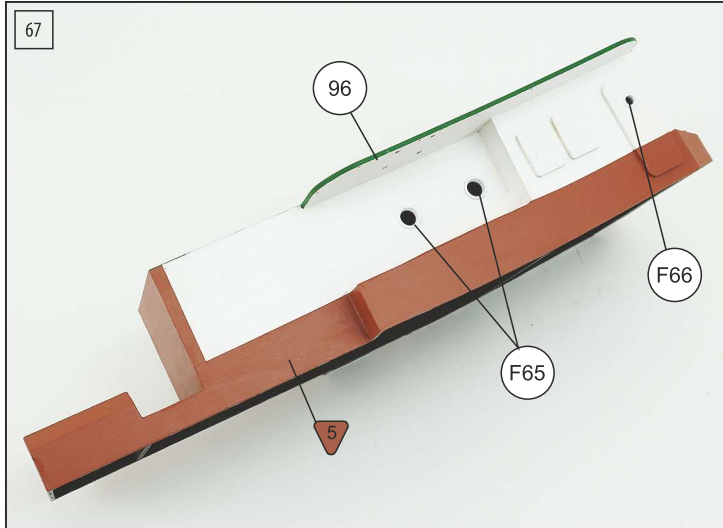
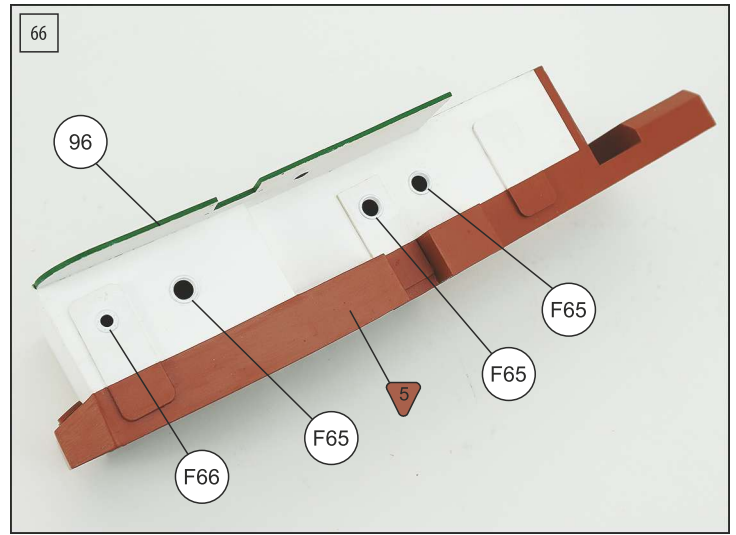
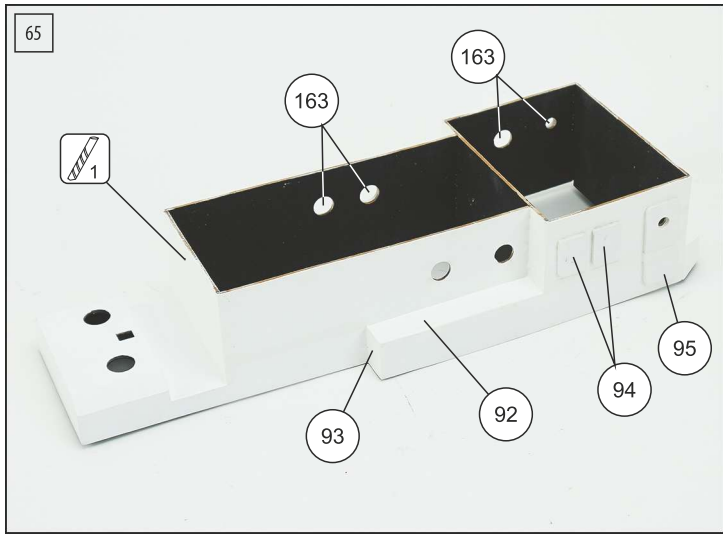



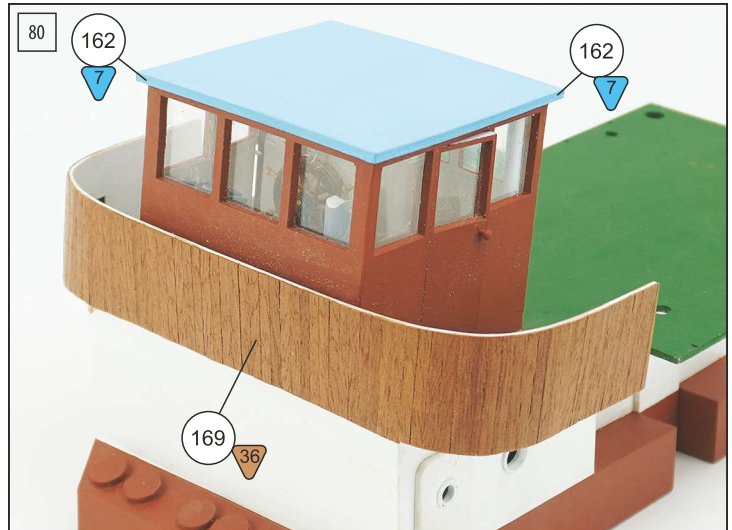
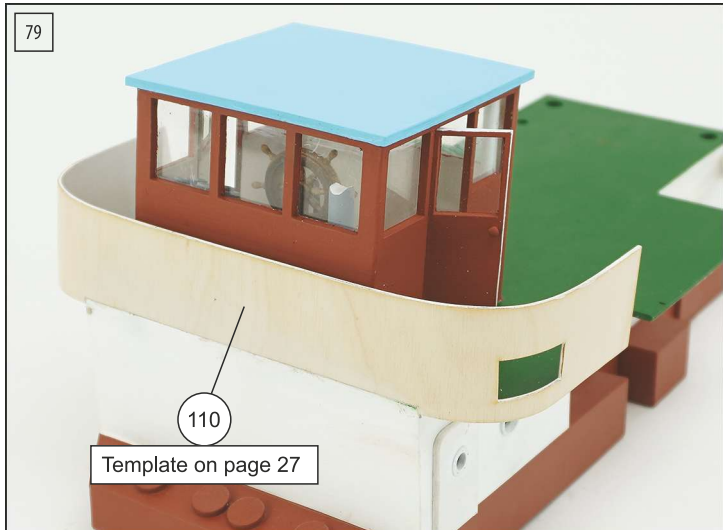
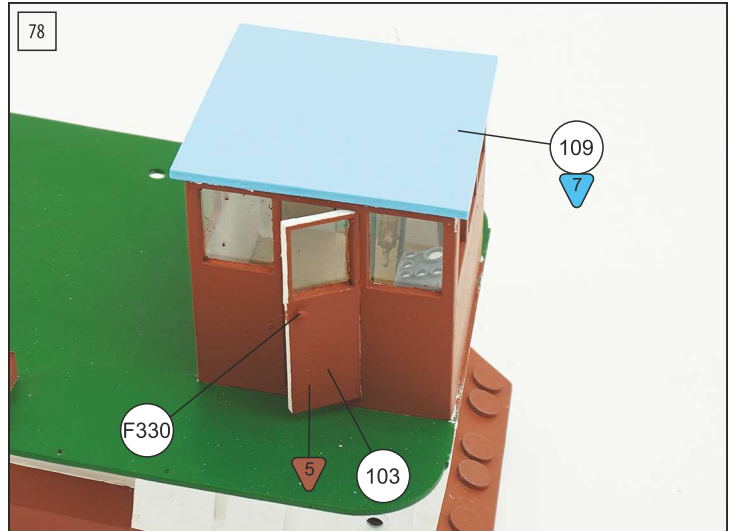
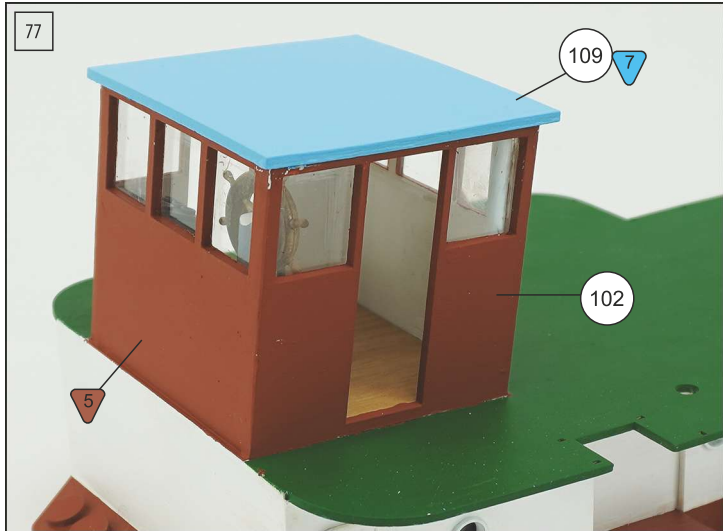
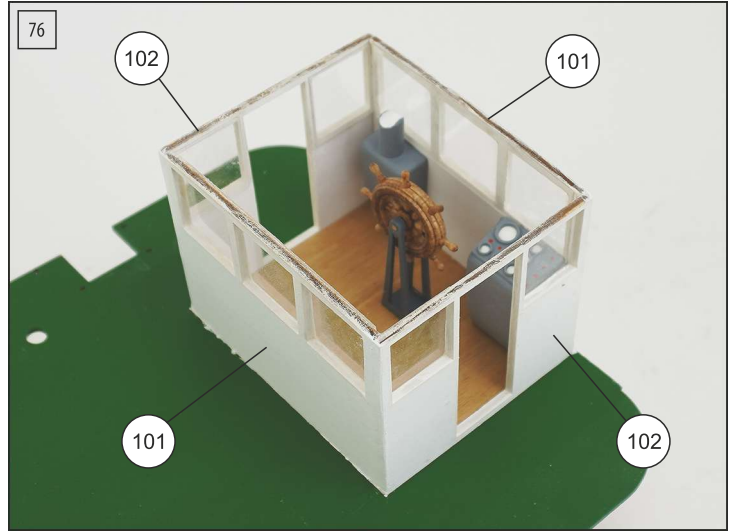
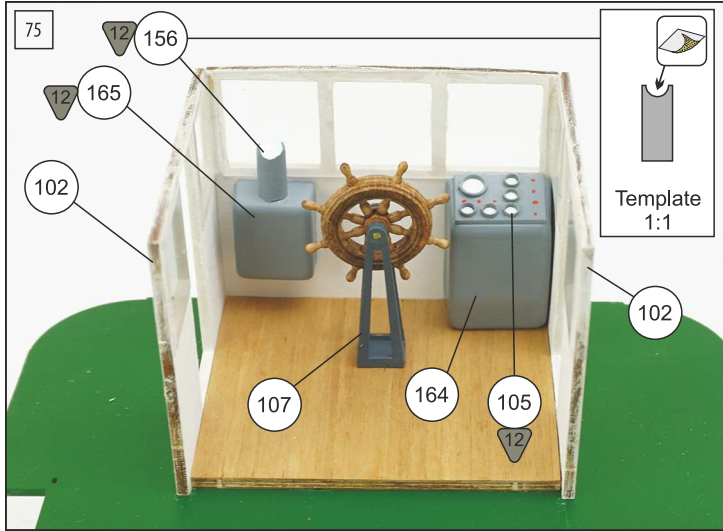
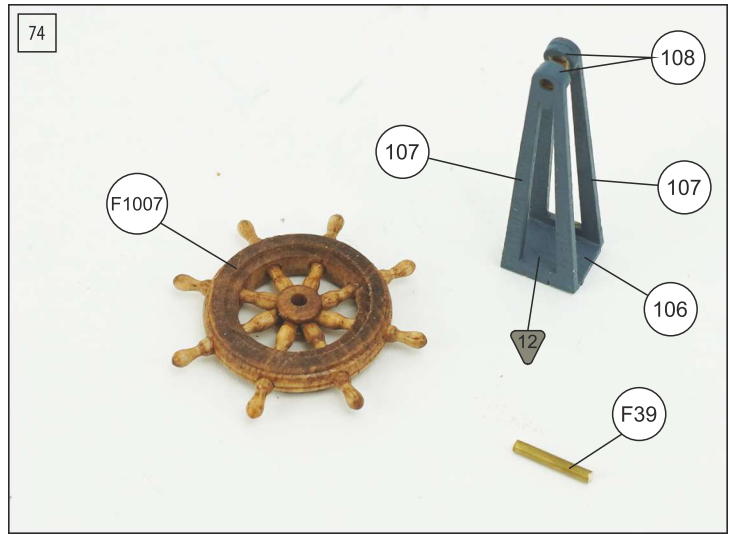
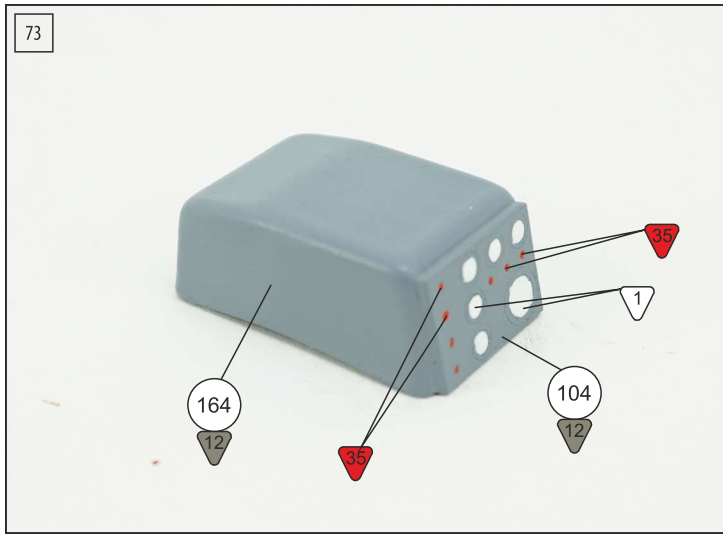



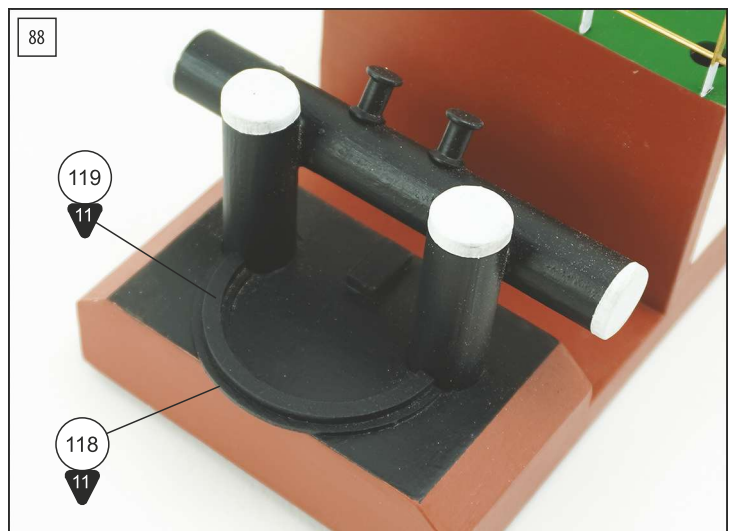
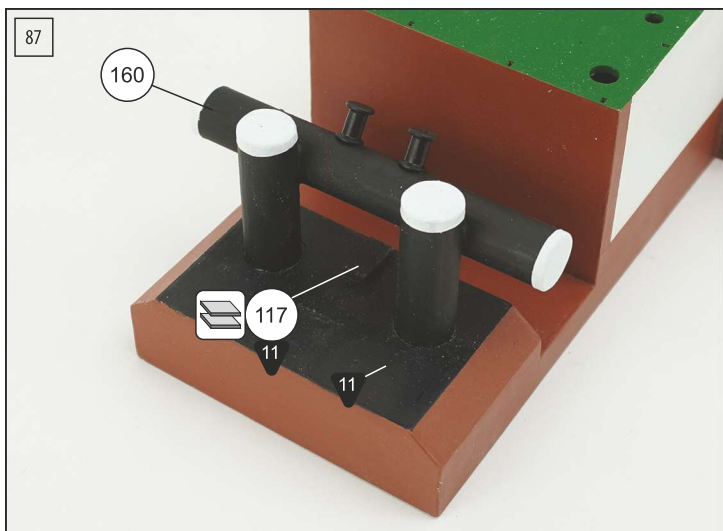
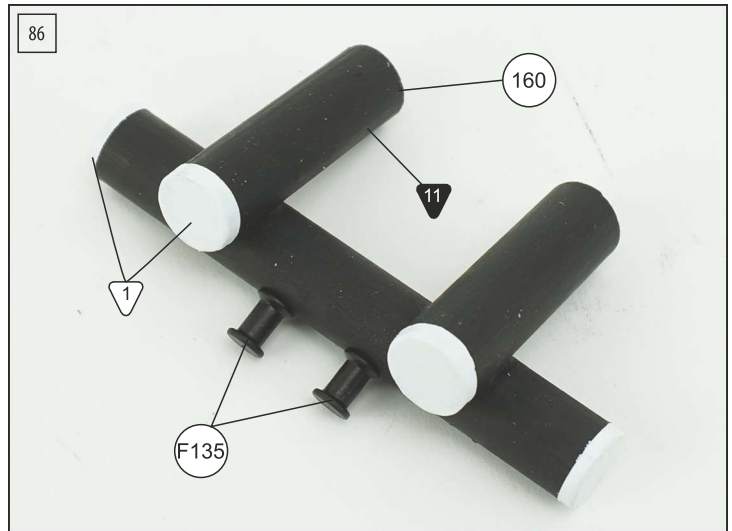
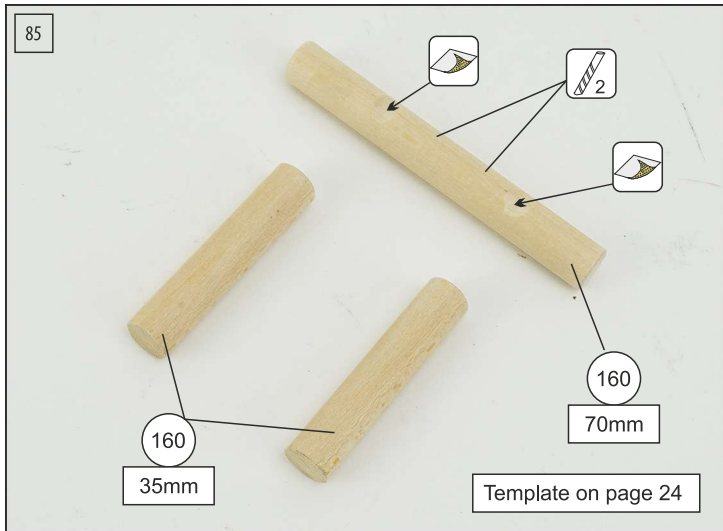
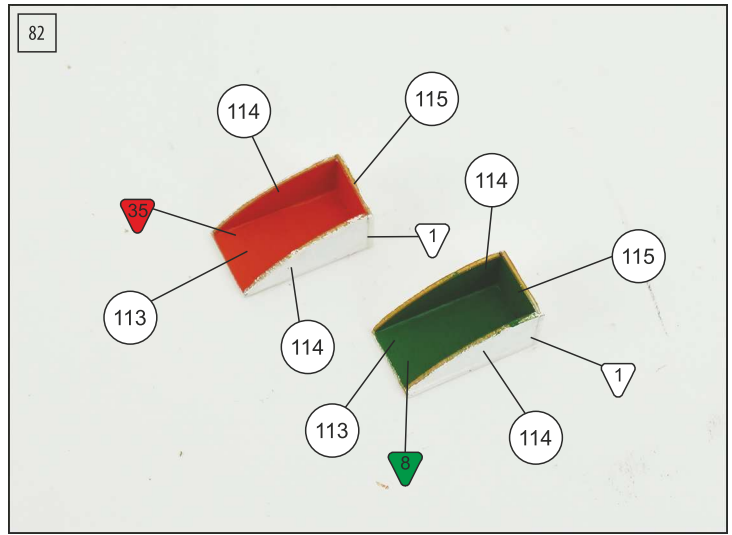

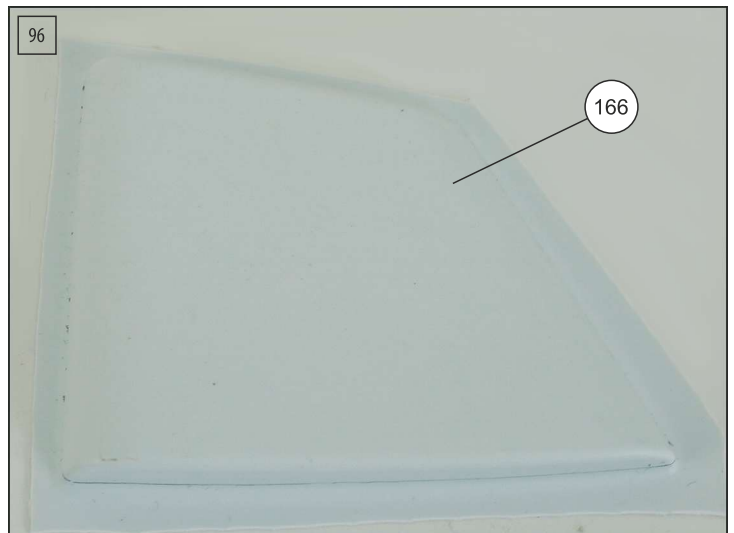
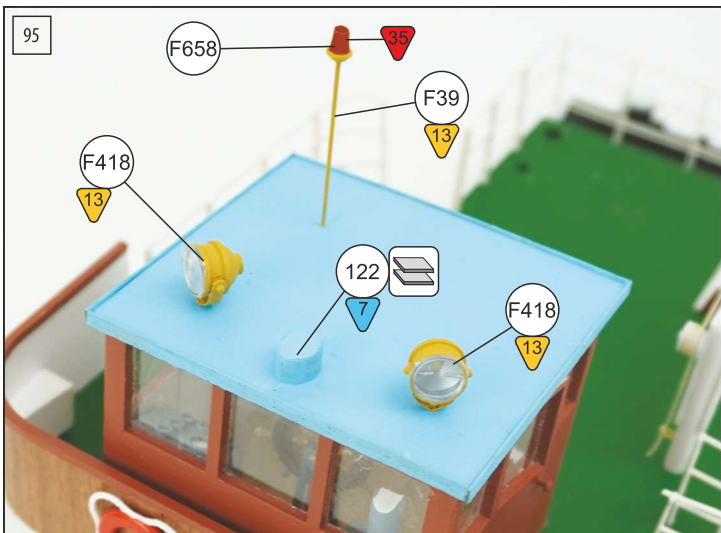
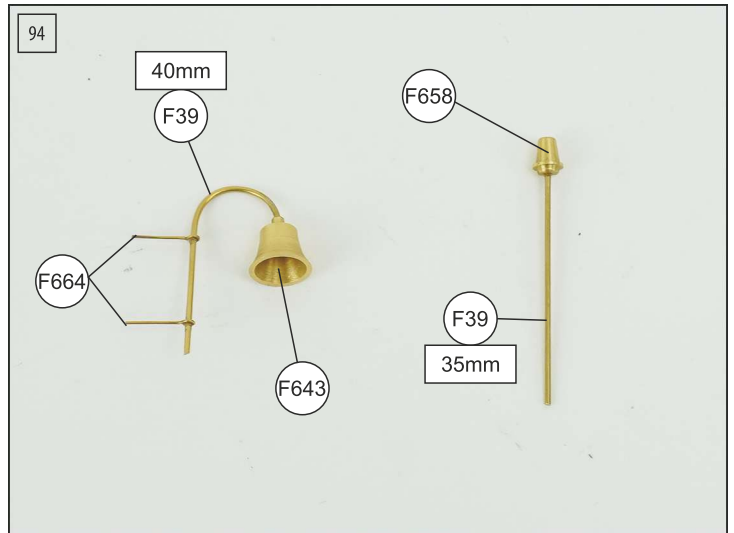
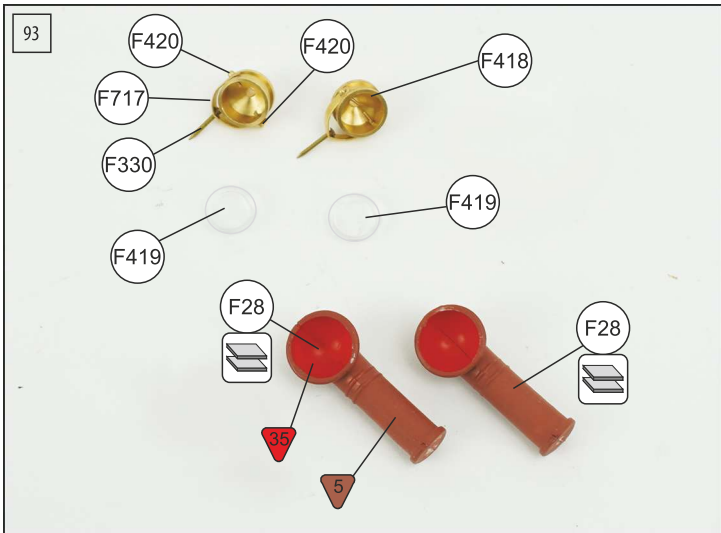
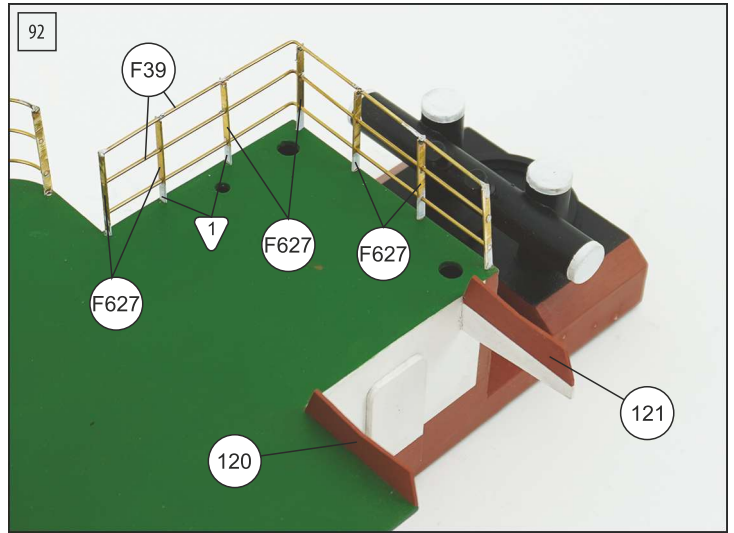
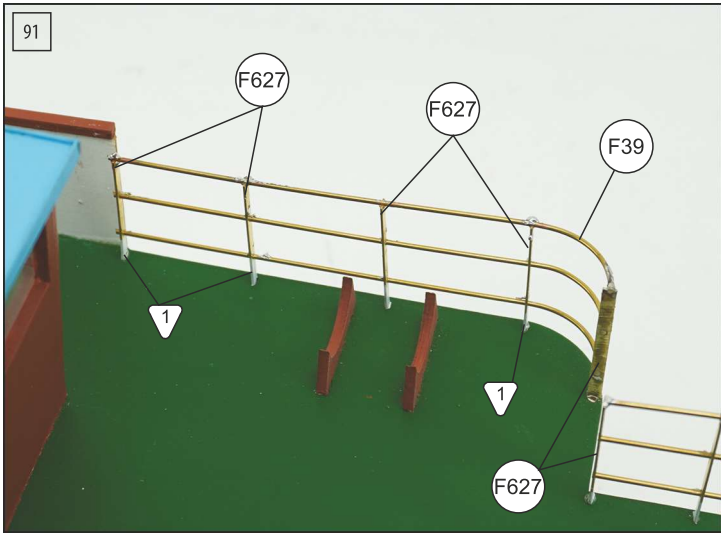
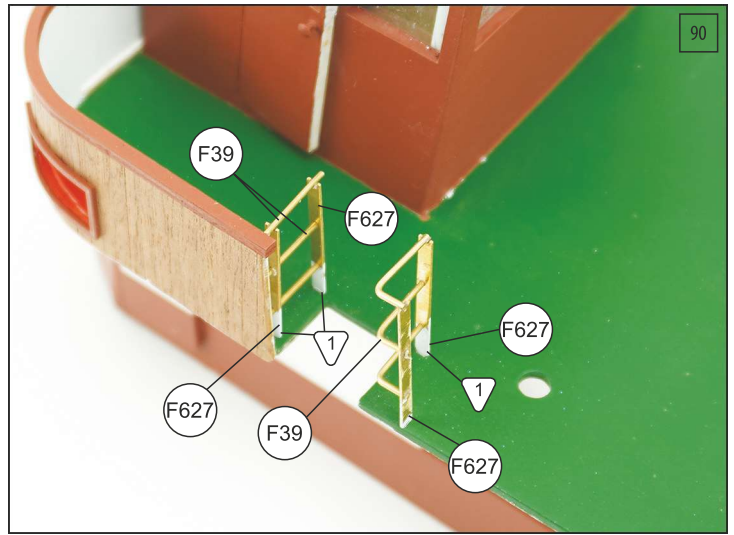



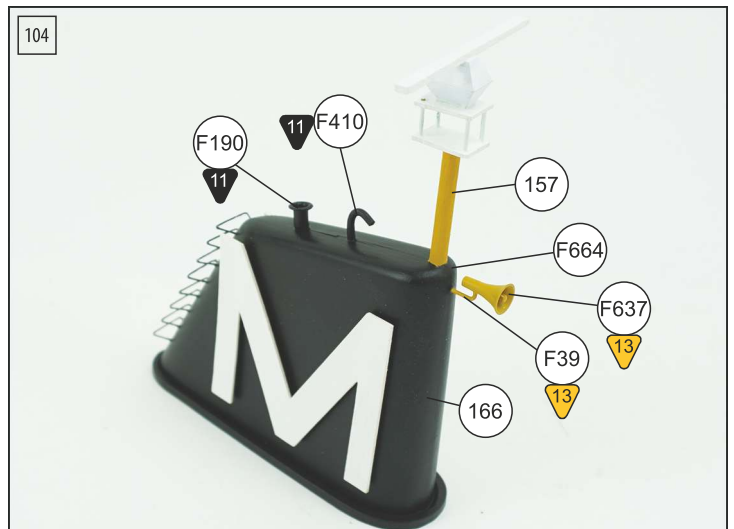
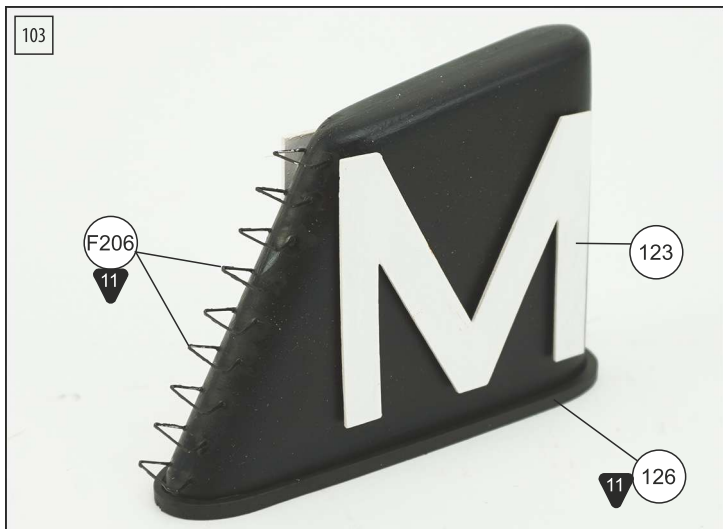
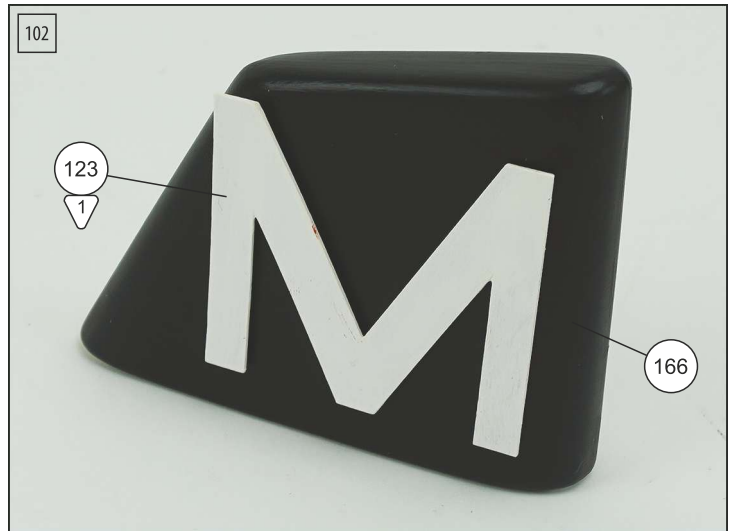
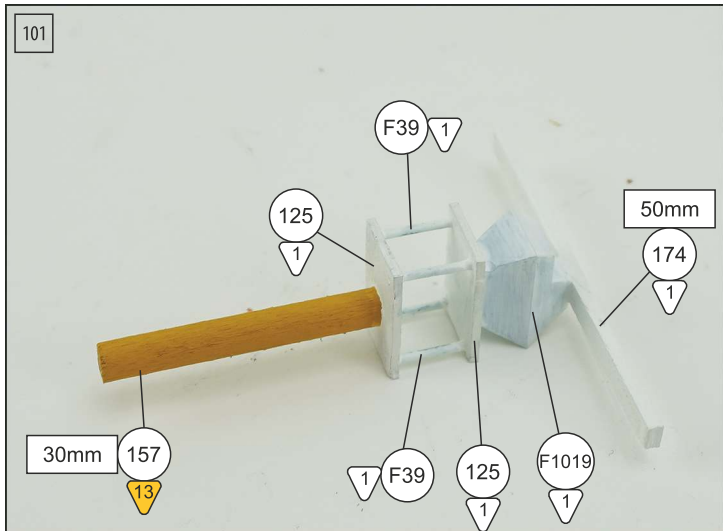
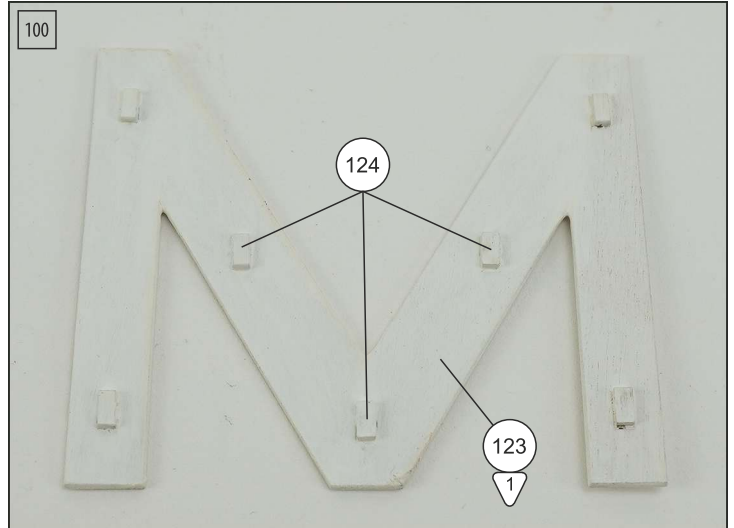
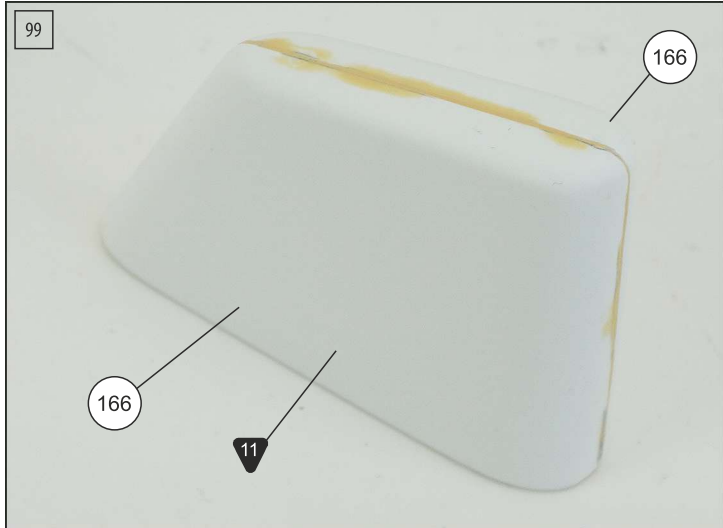
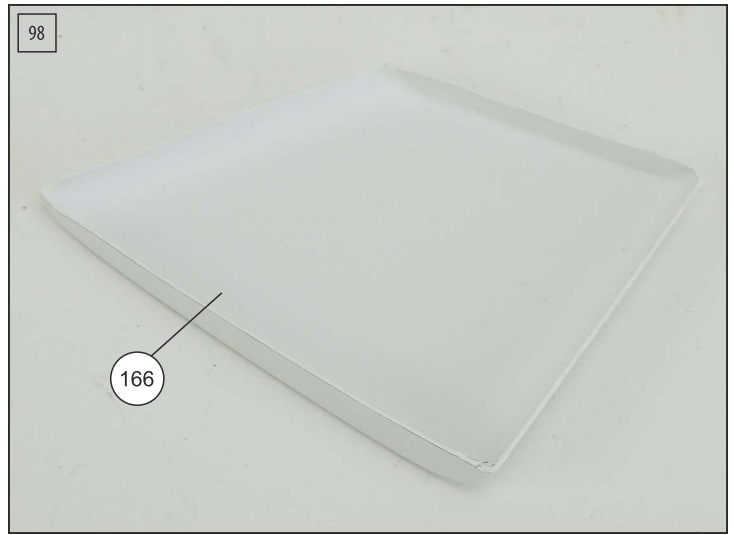
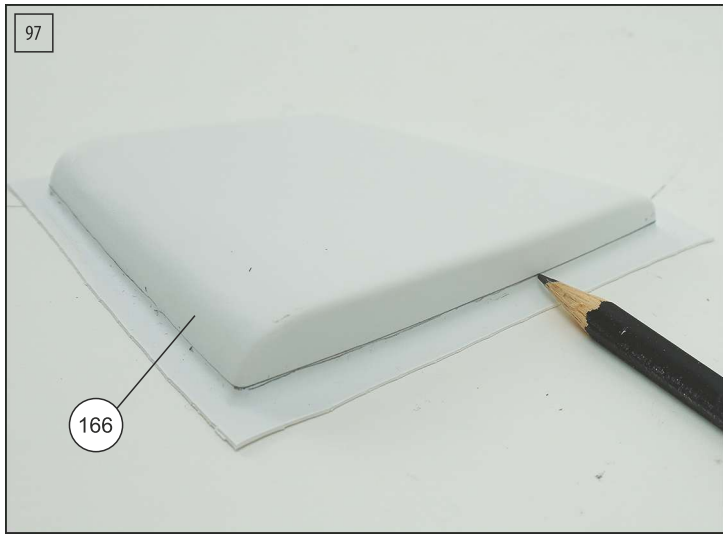



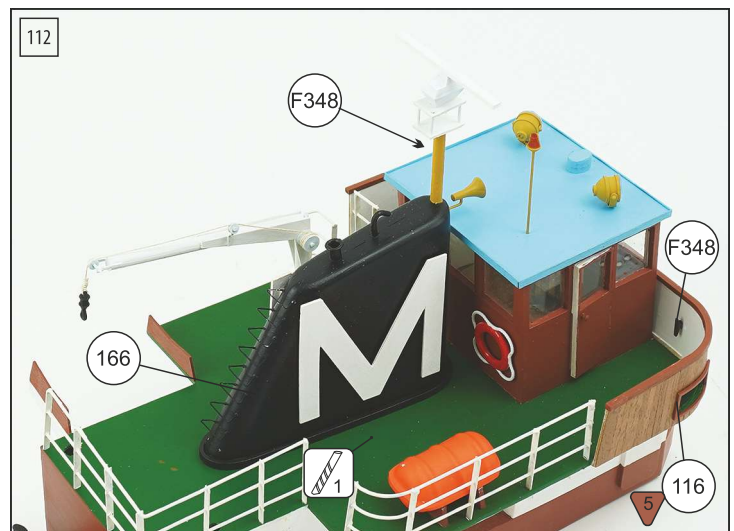
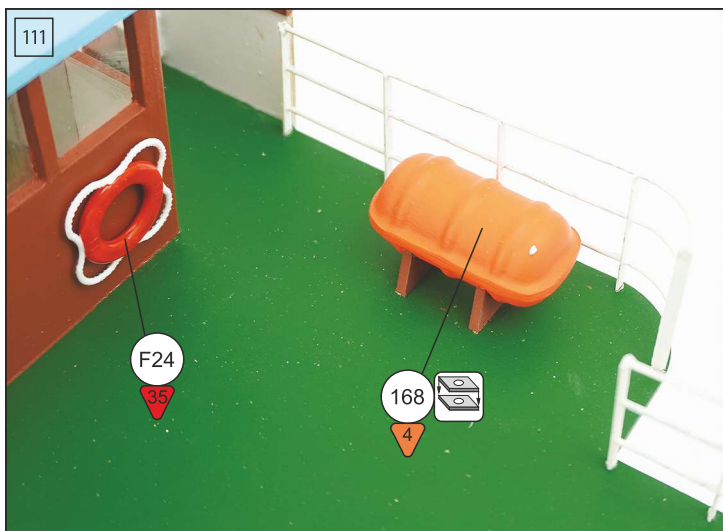
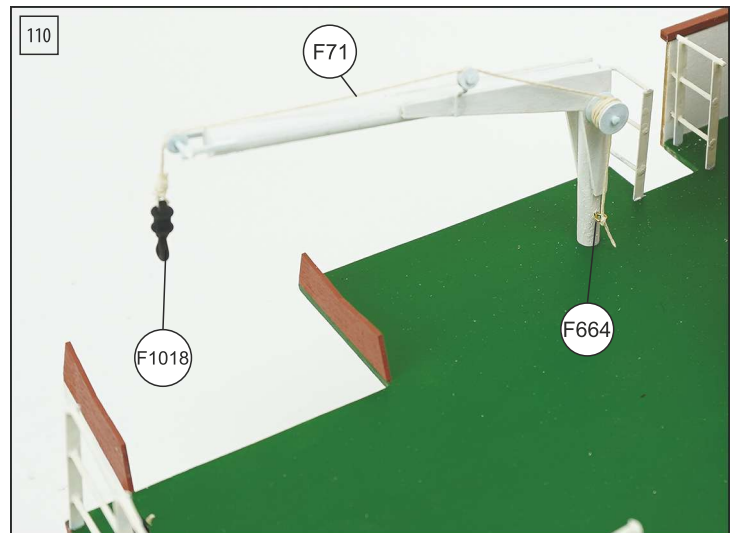
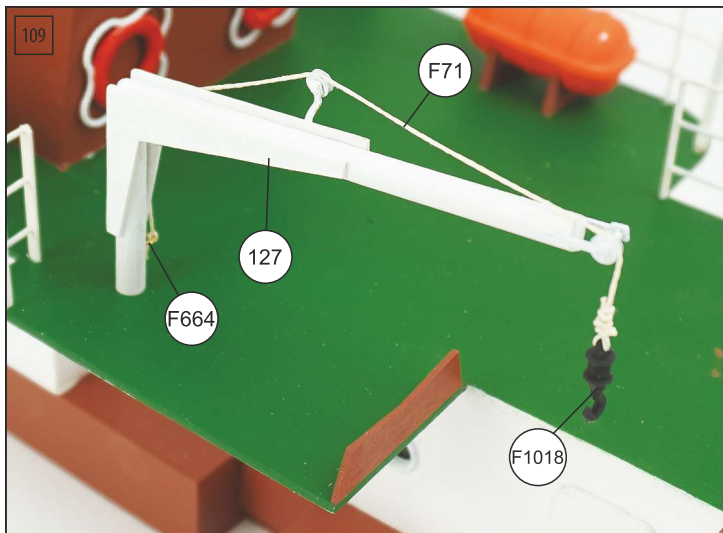
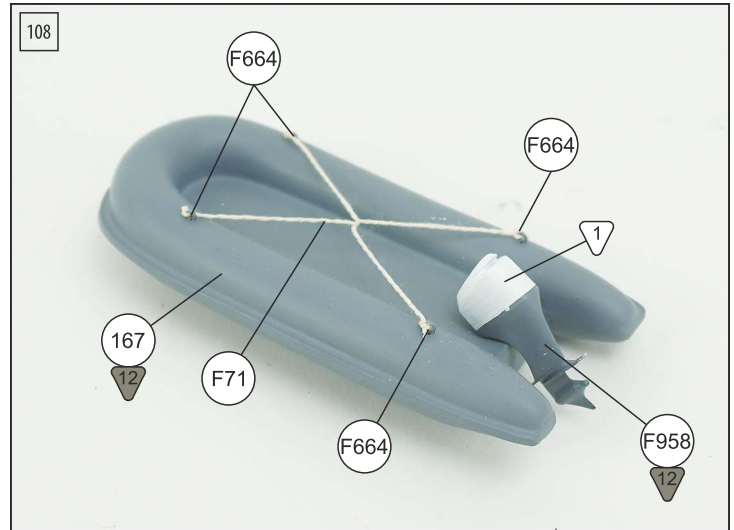
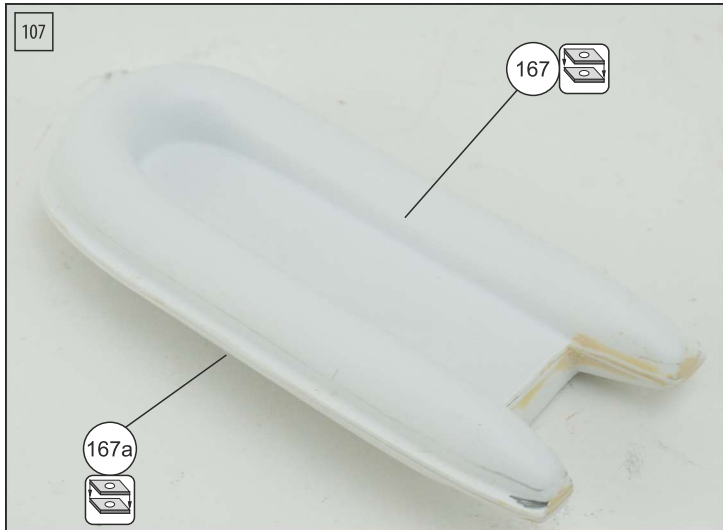
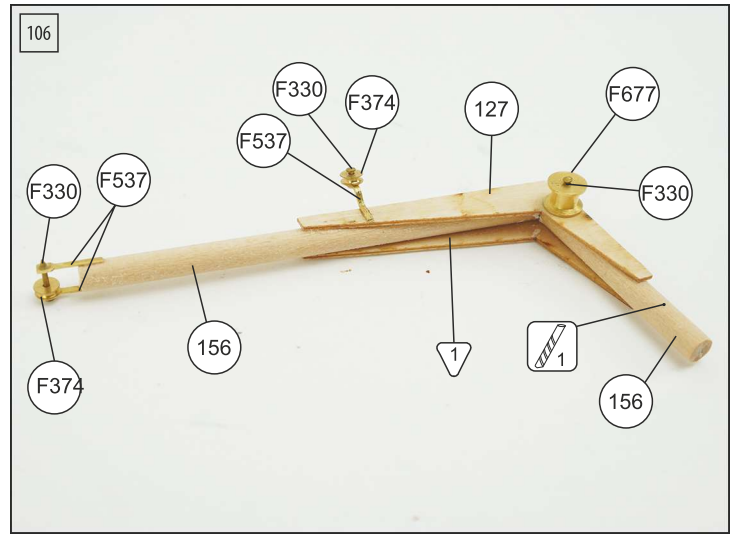
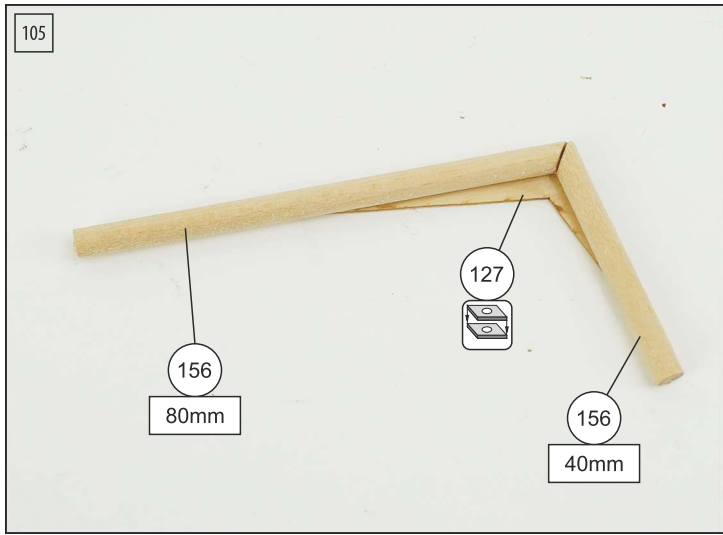

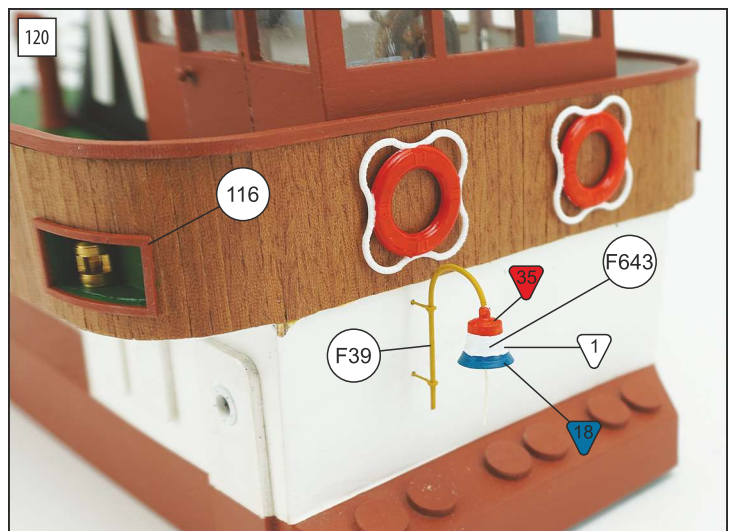
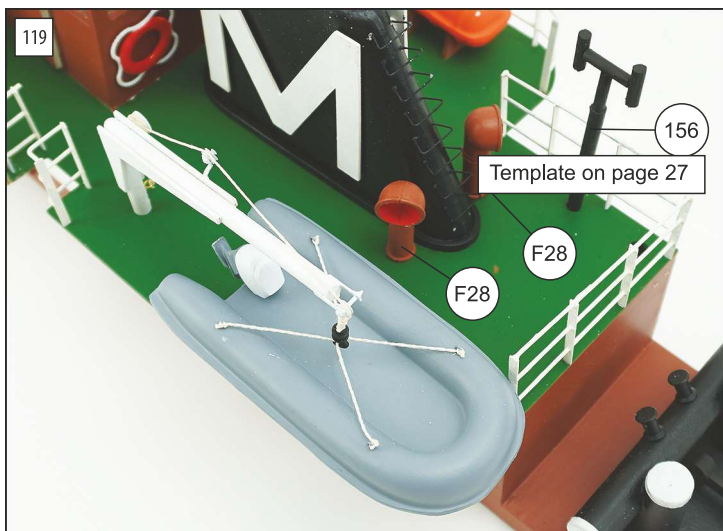
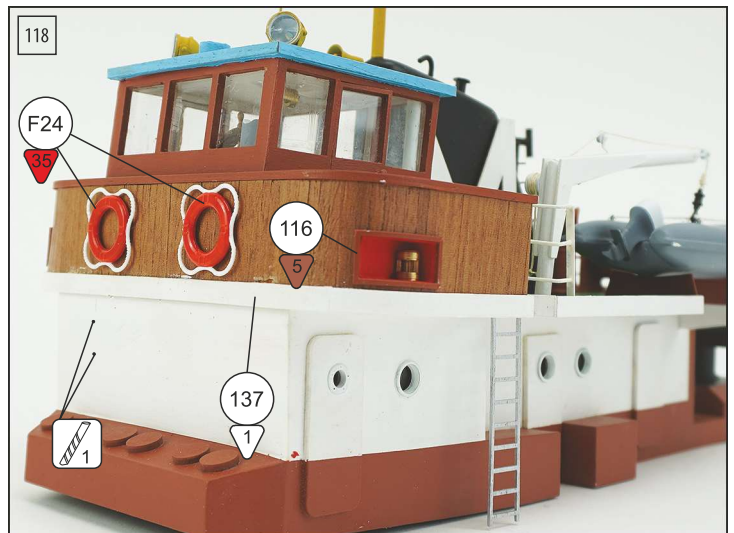
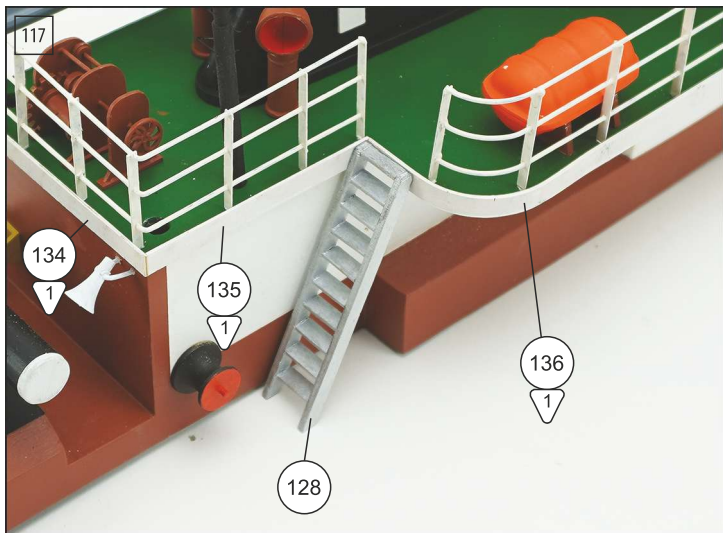
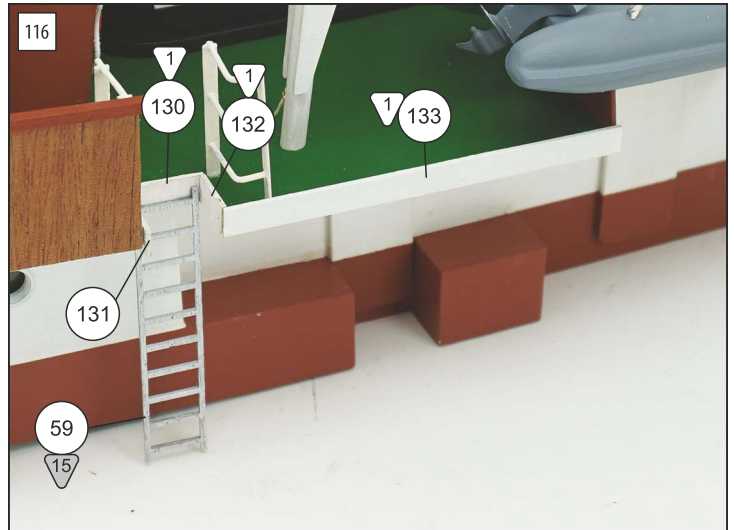
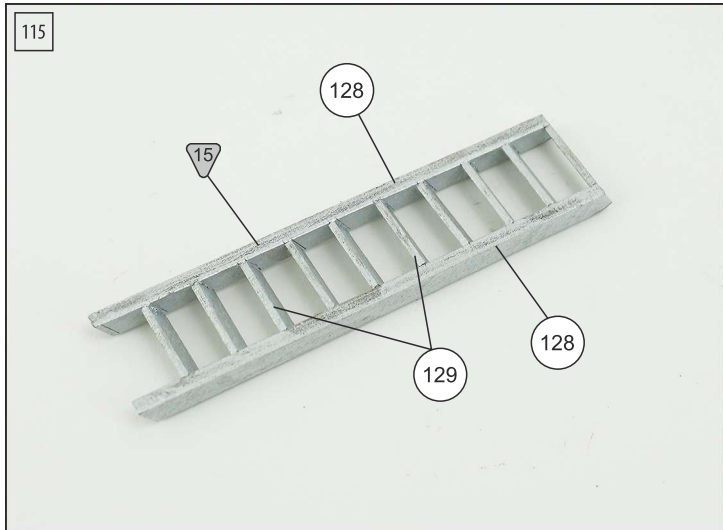
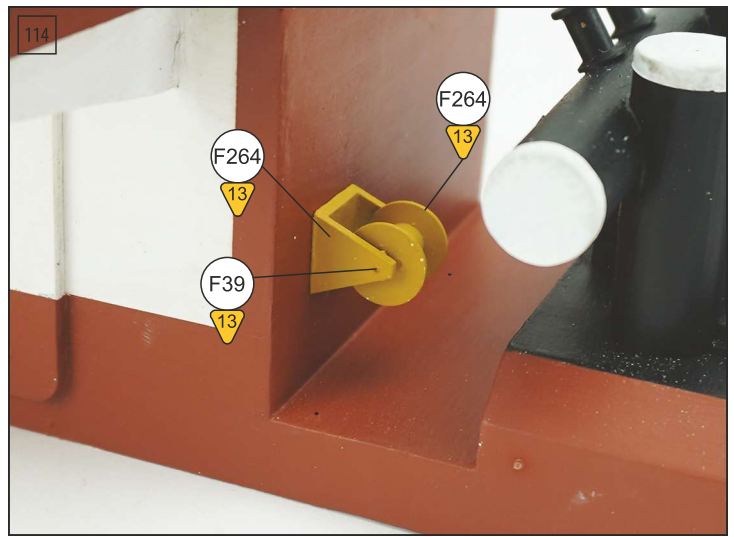
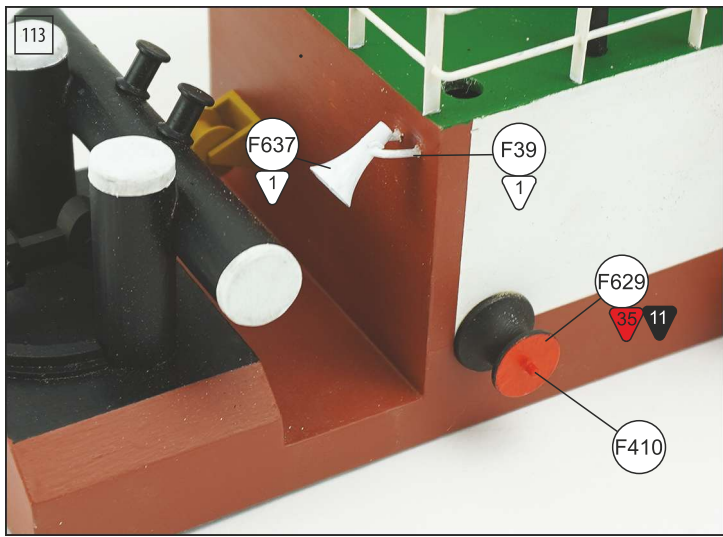



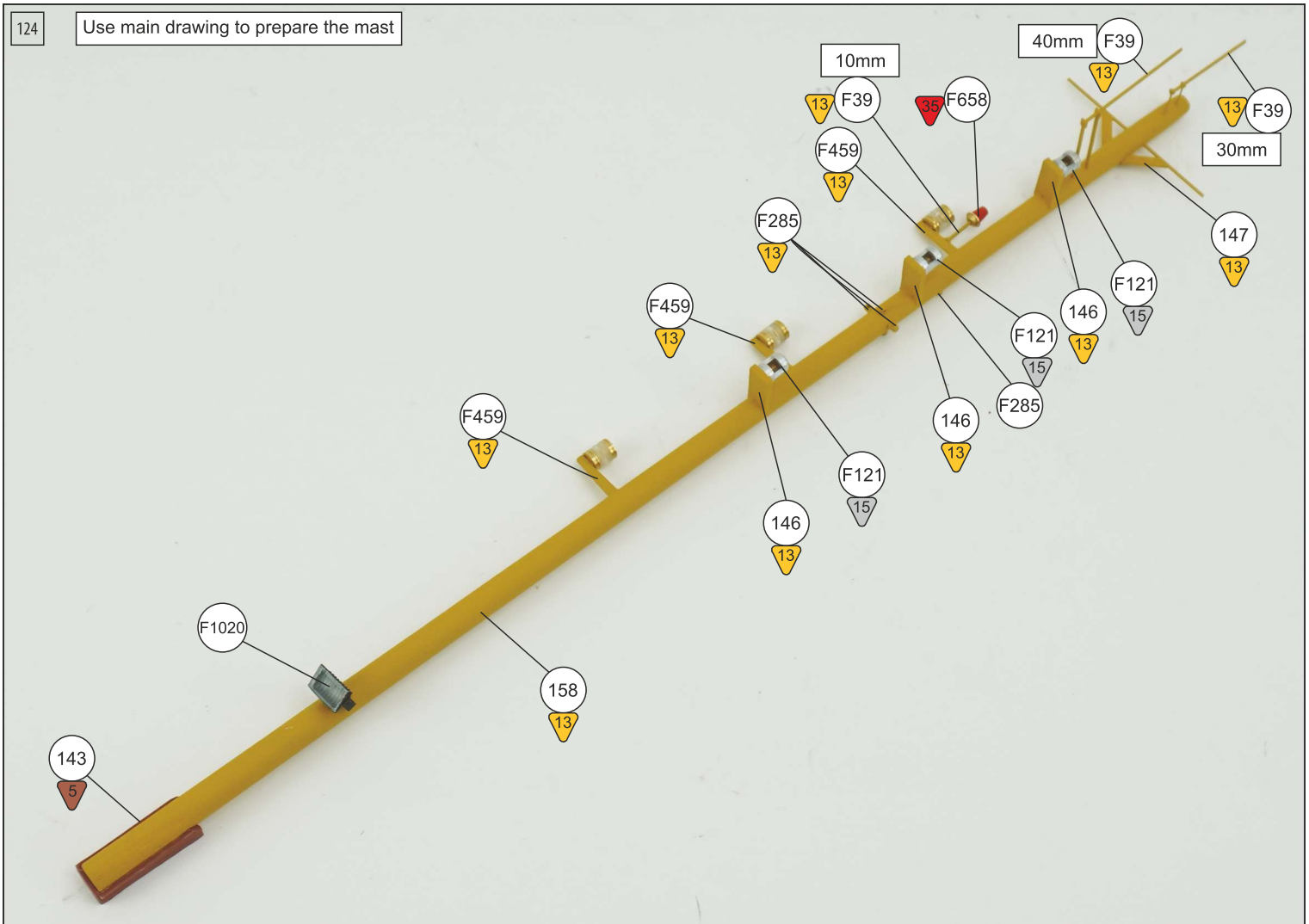
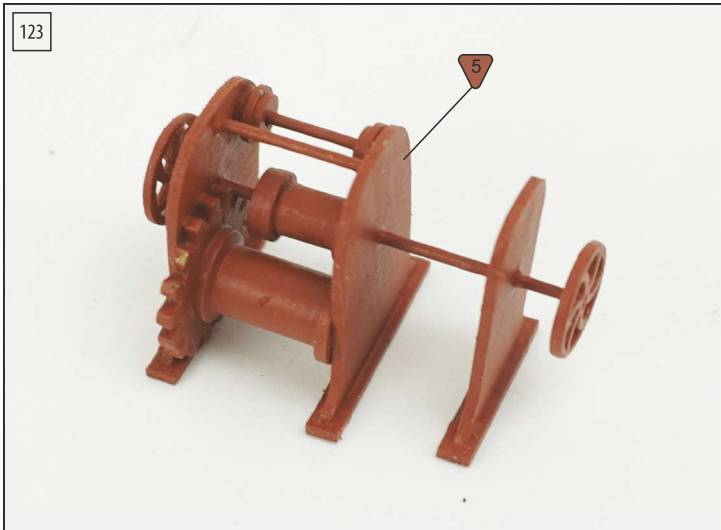
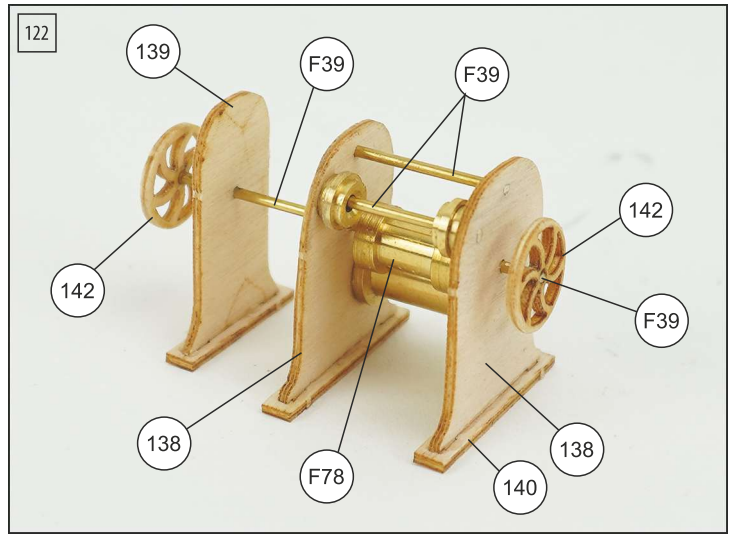
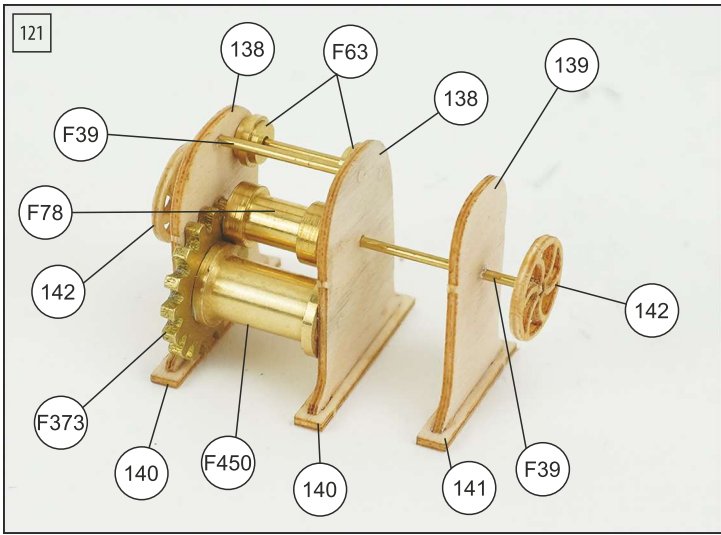

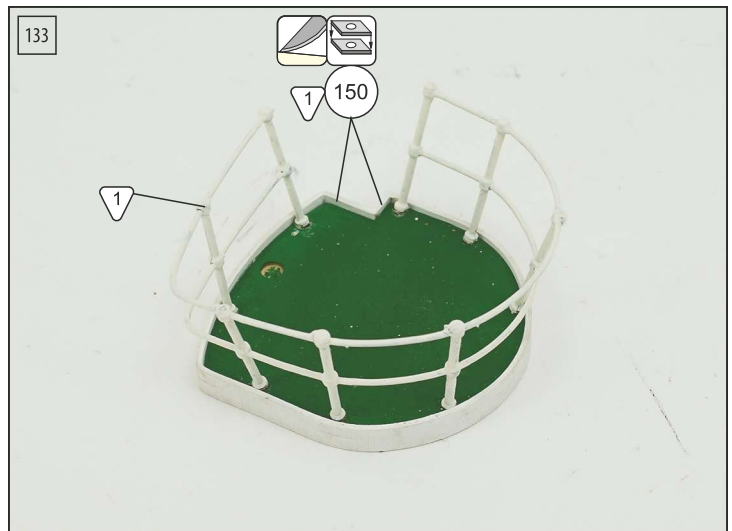
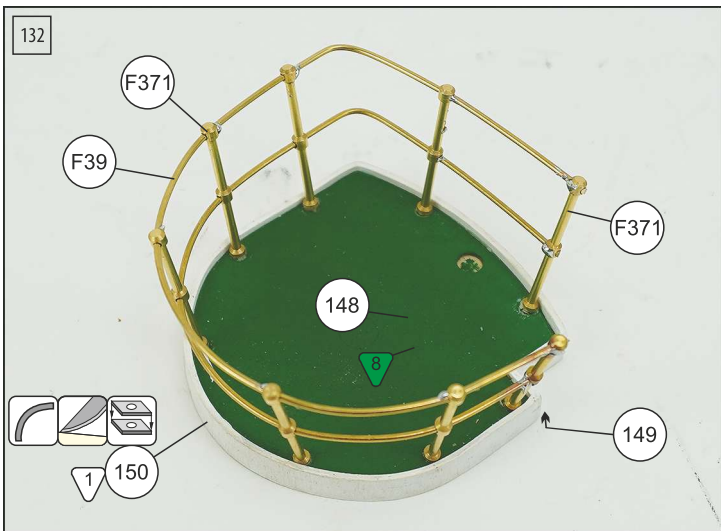
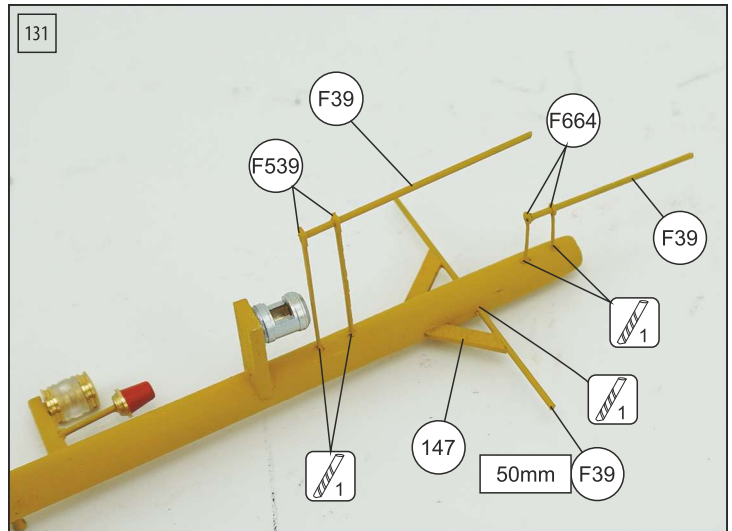
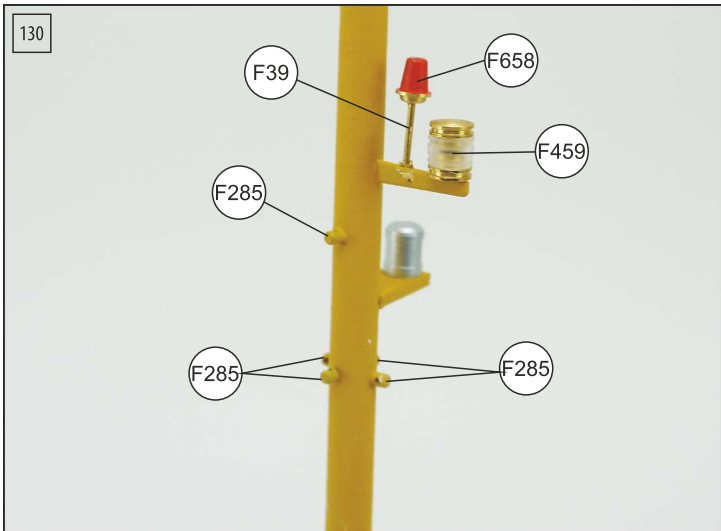
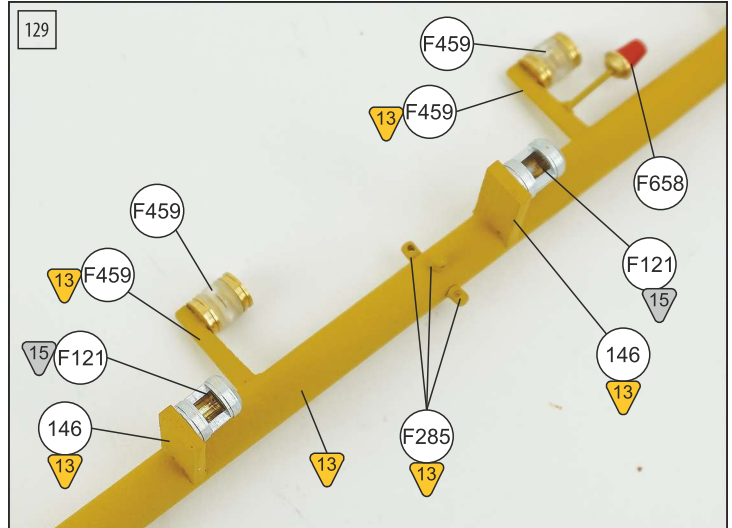
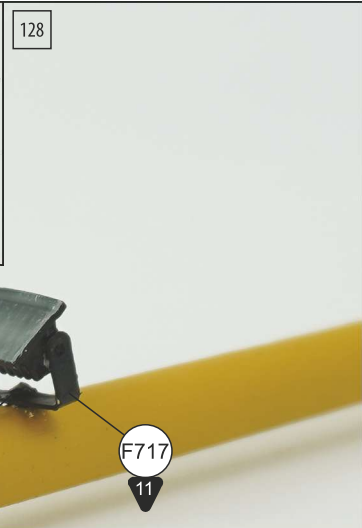
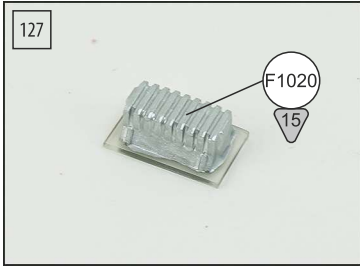
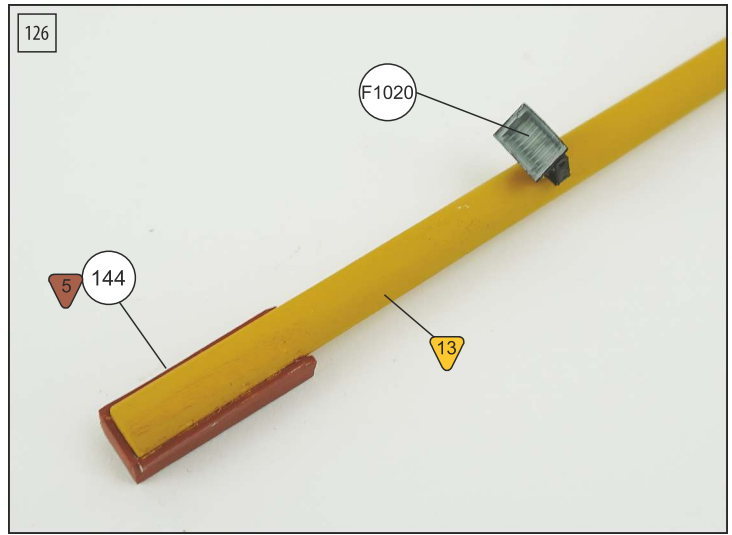
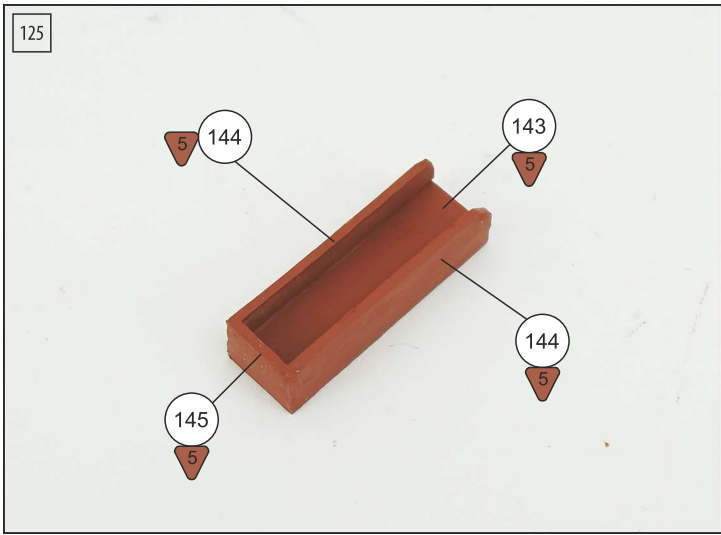



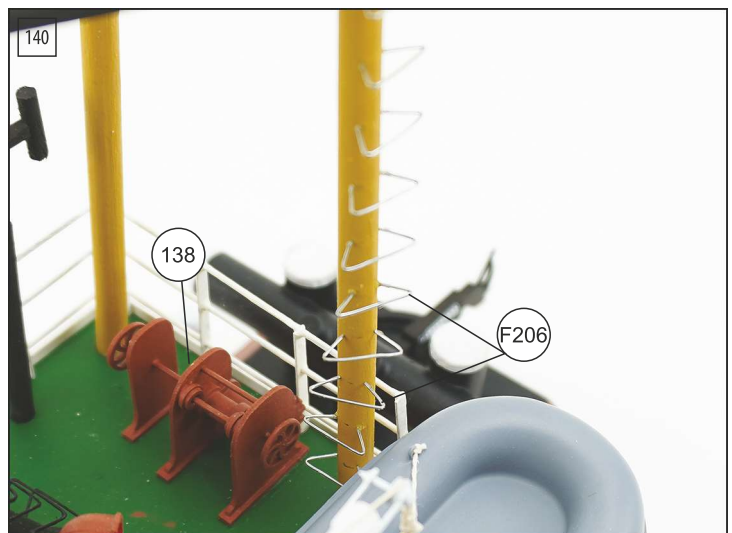
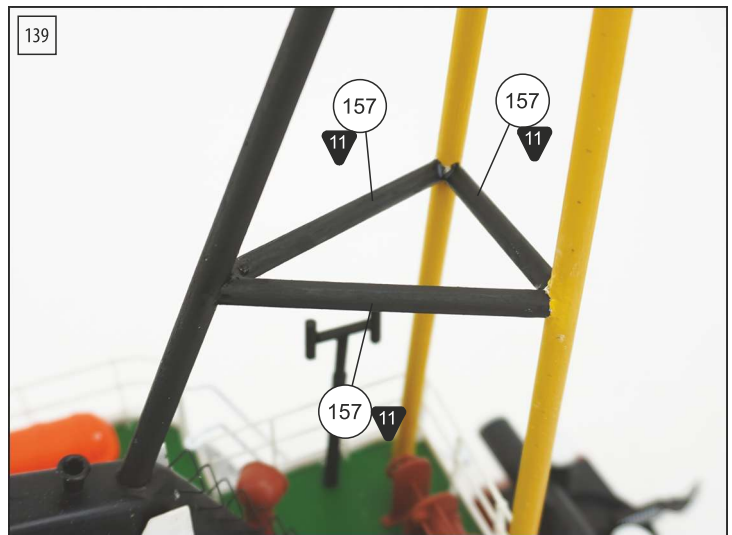
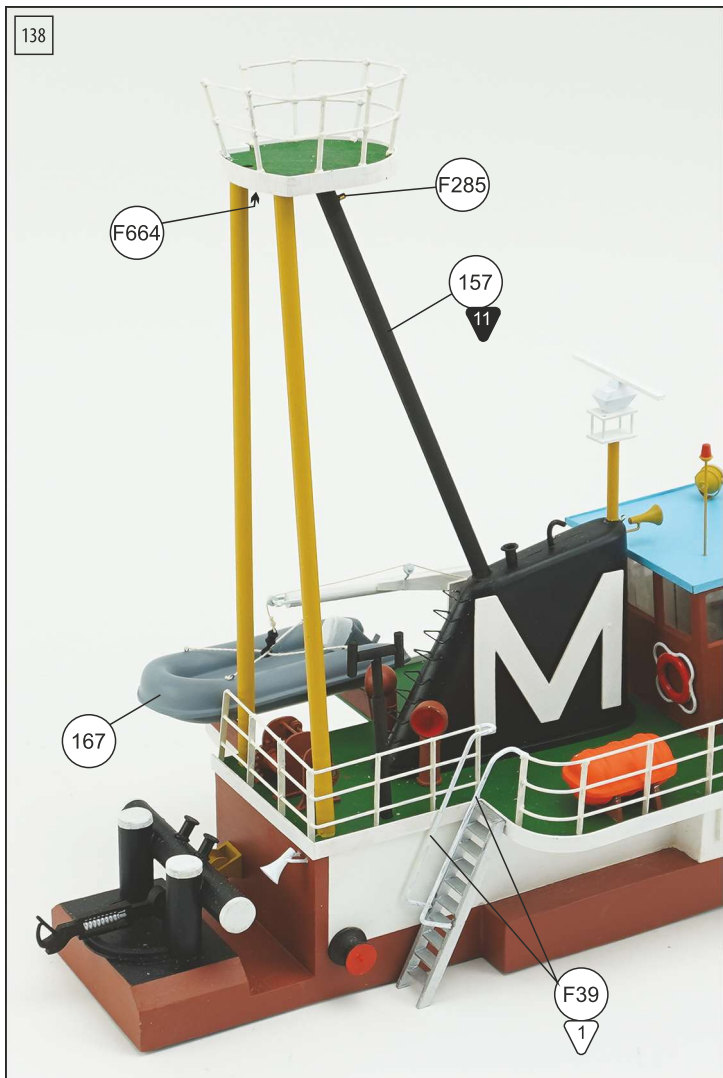
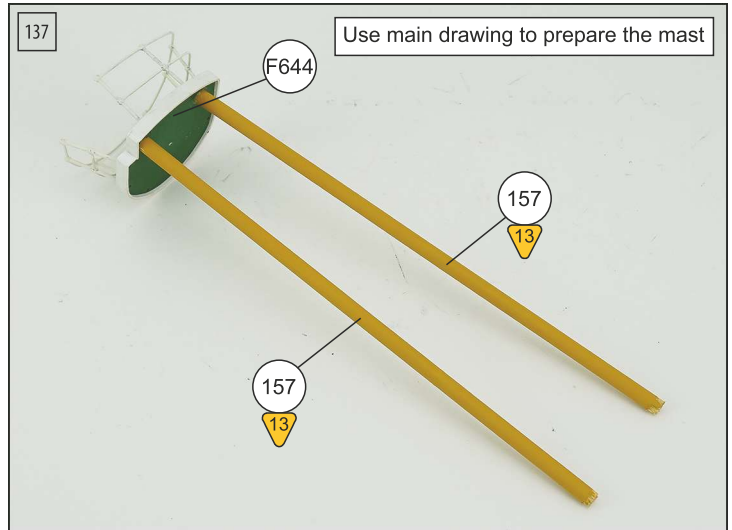
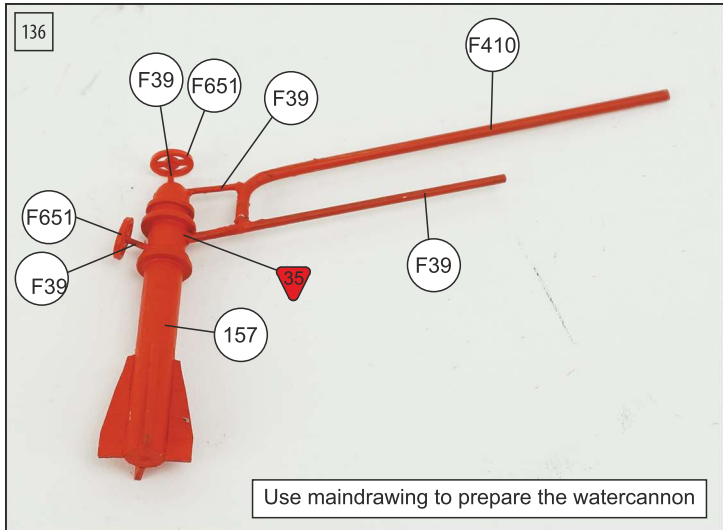
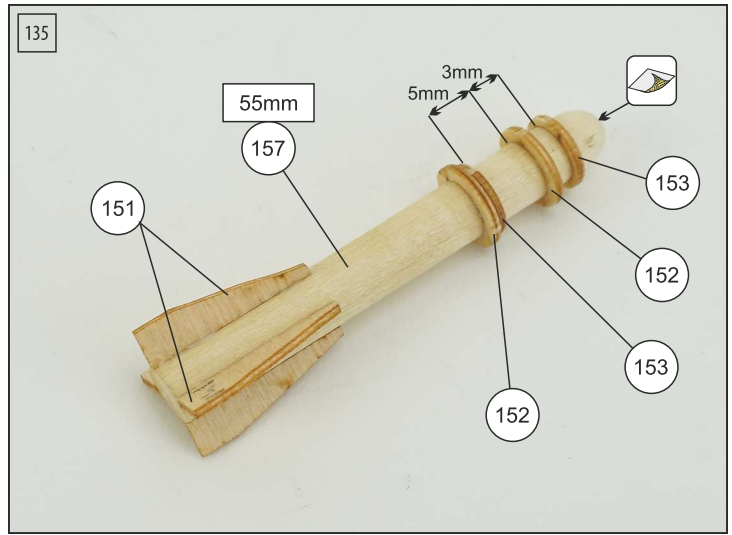
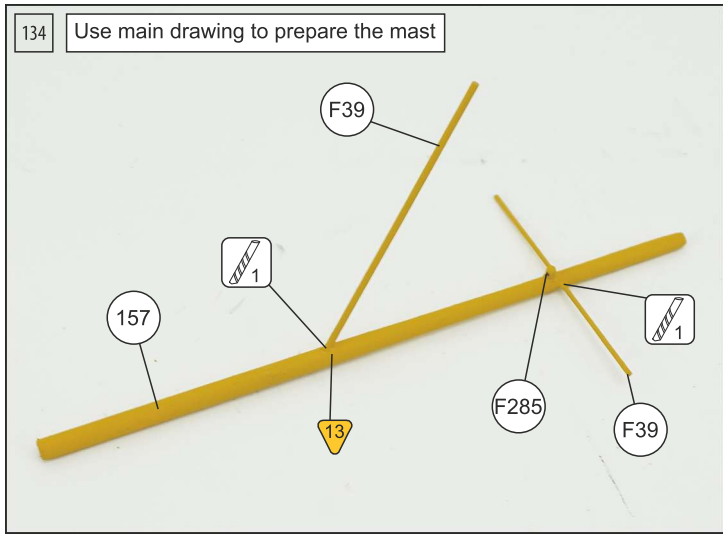

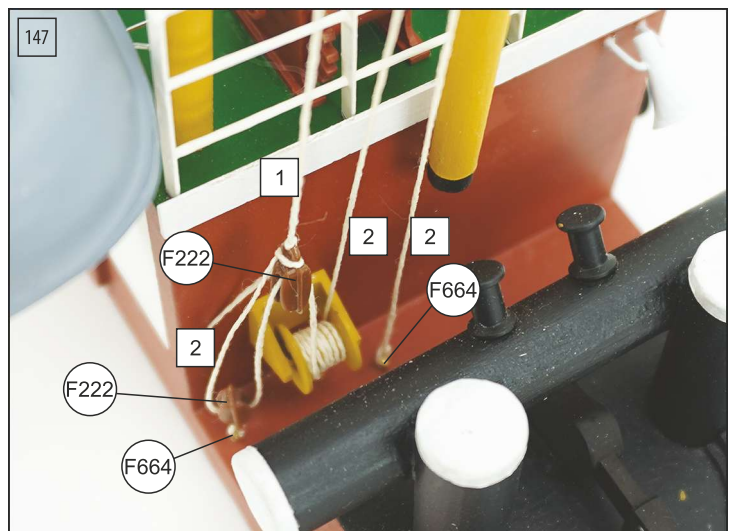
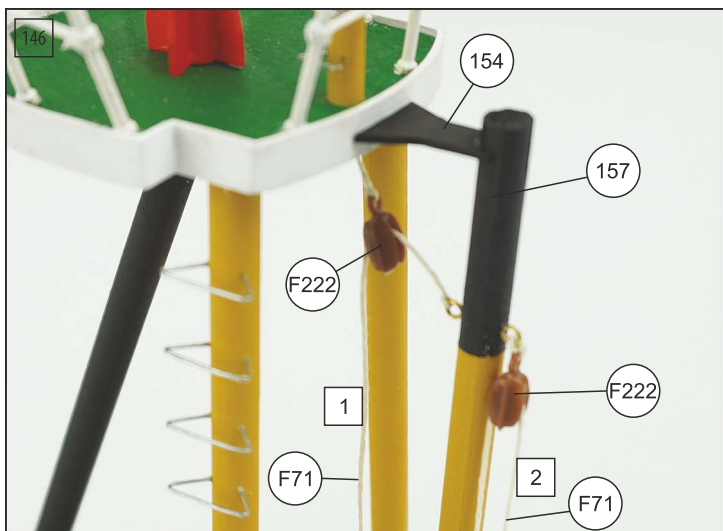
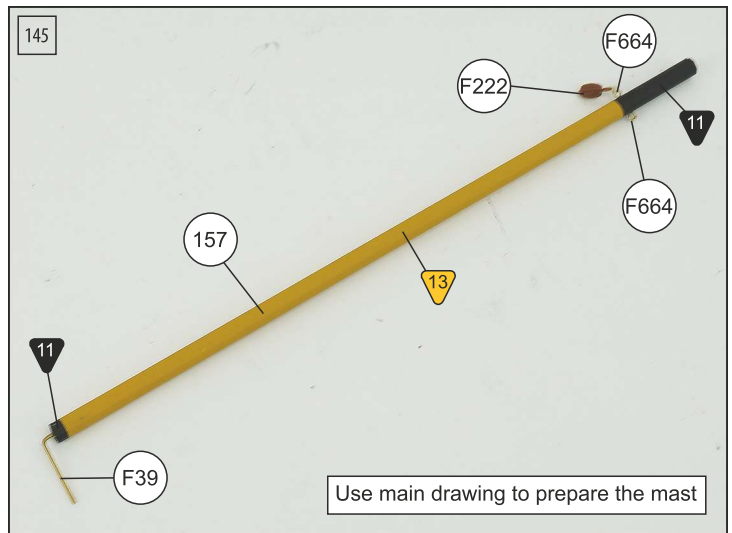
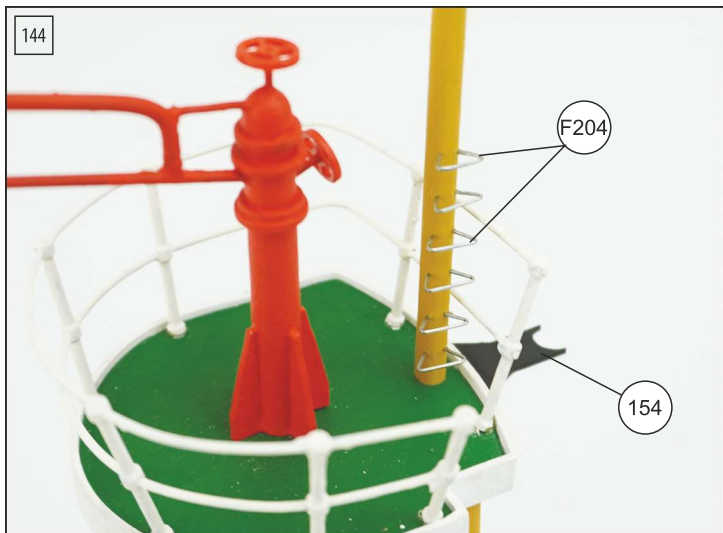
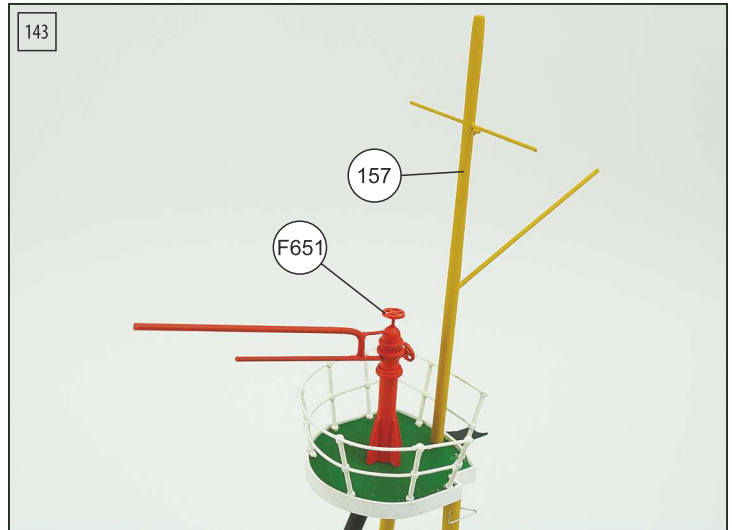
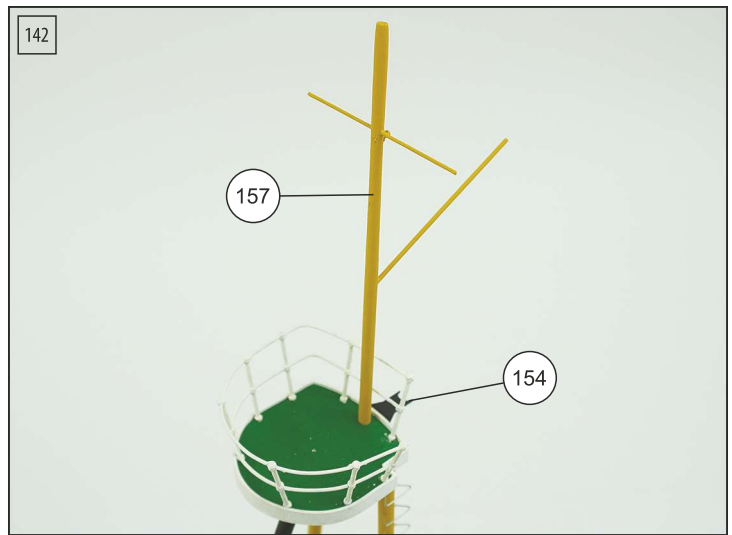
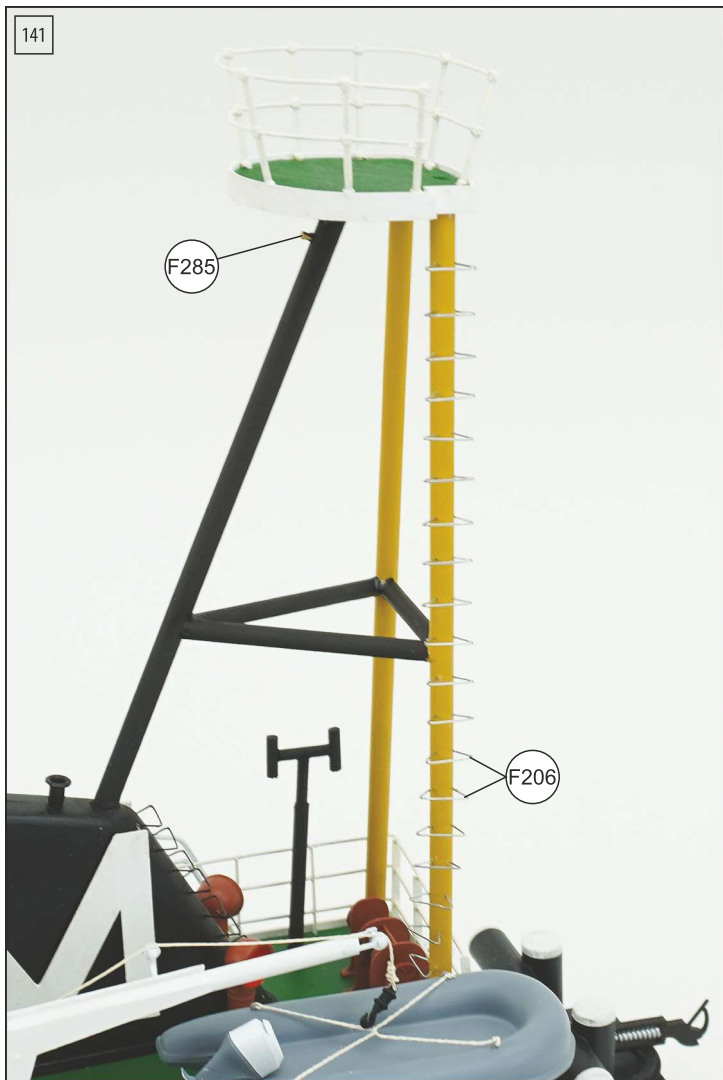



Use maindrawing to prepare the rigging

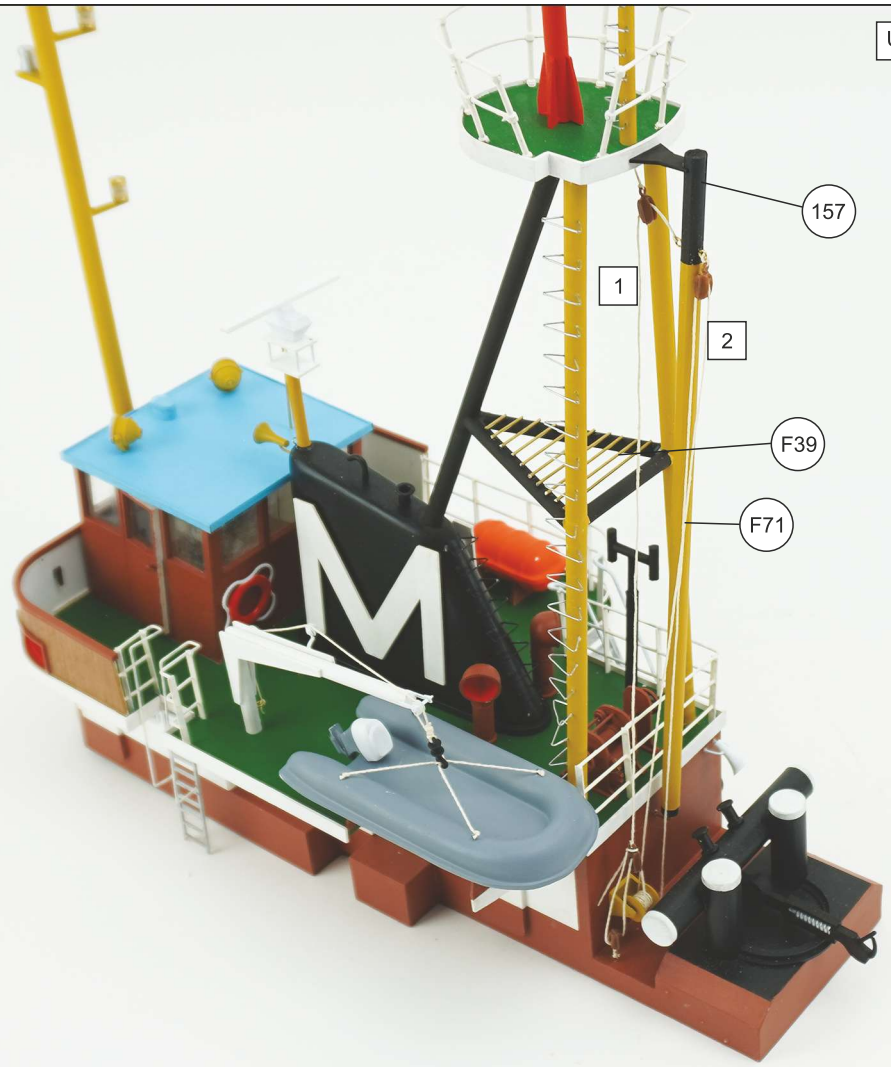

Use maindrawing to prepare the rigging

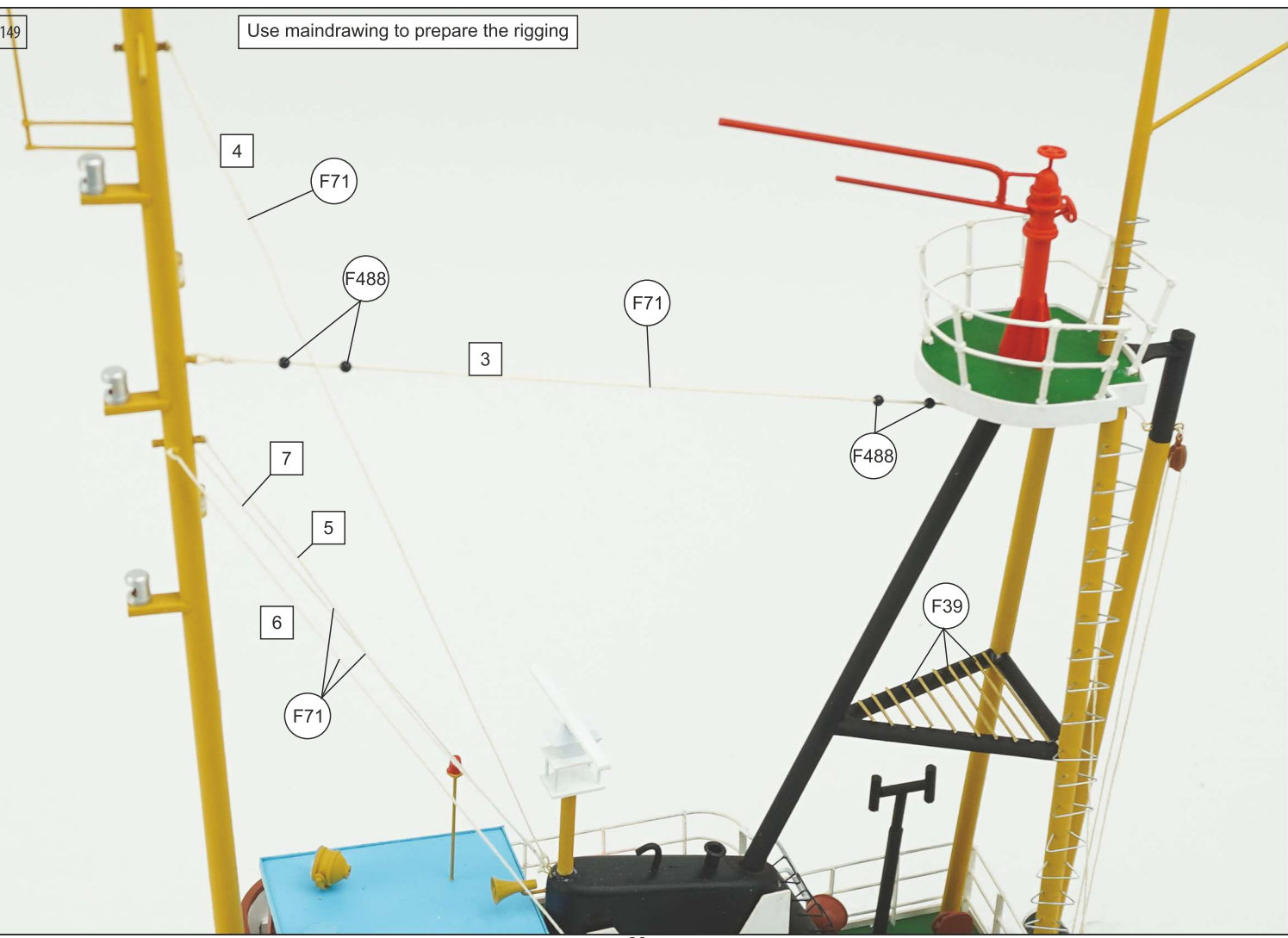

Use maindrawing to prepare the rigging

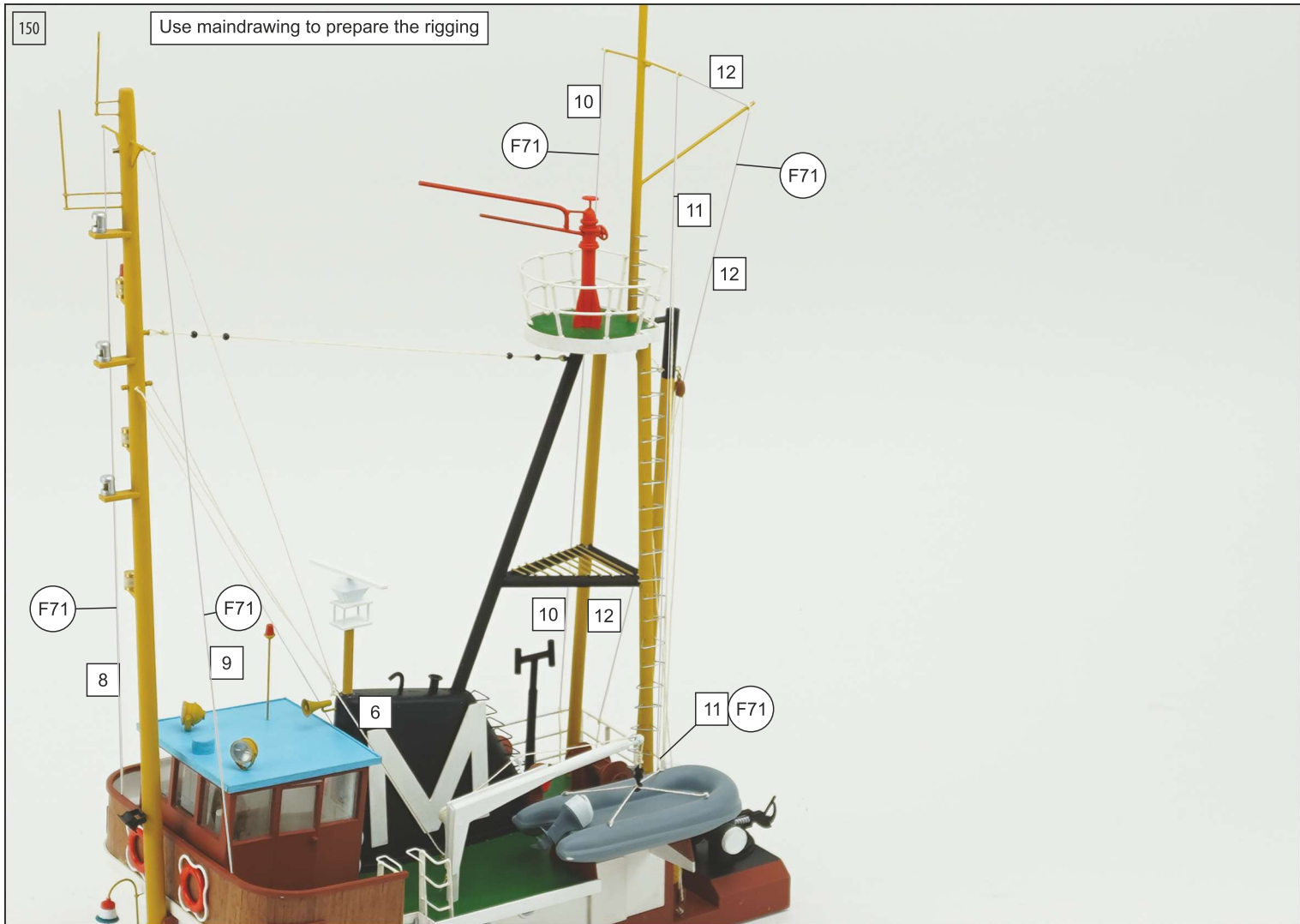

Template Photo 28 scale 1:1

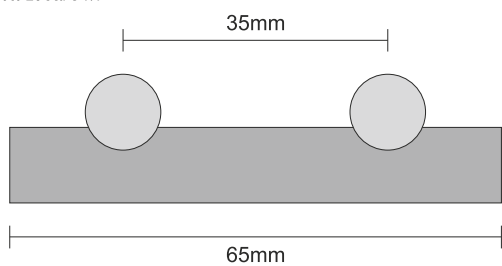

TOP

Template Photo 85 scale 1:1

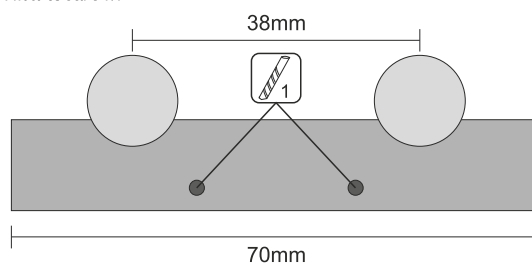

TOP

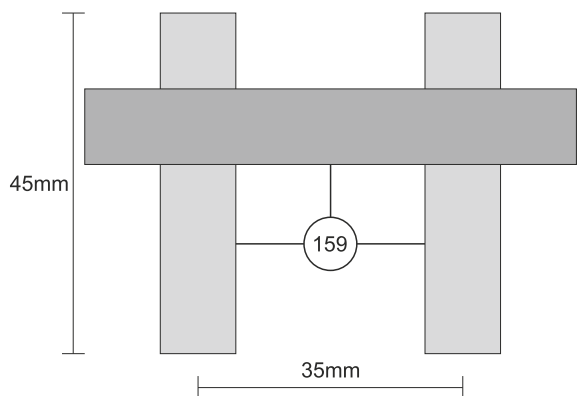

FRONT

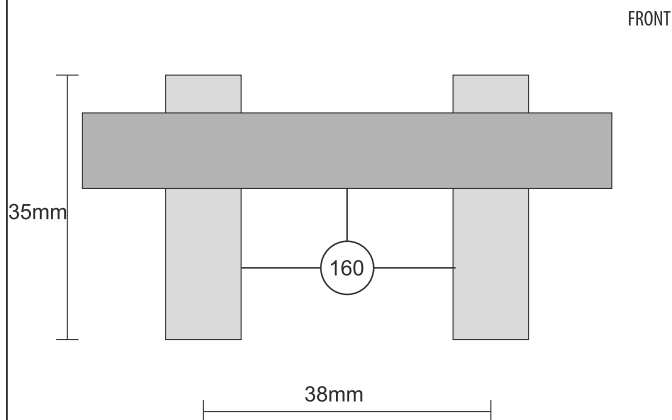

FRONT





152

Prepare 2 lines min 40cm long  
Fit length when the cabin is on the deck

153

F39

F71

F71

13

14

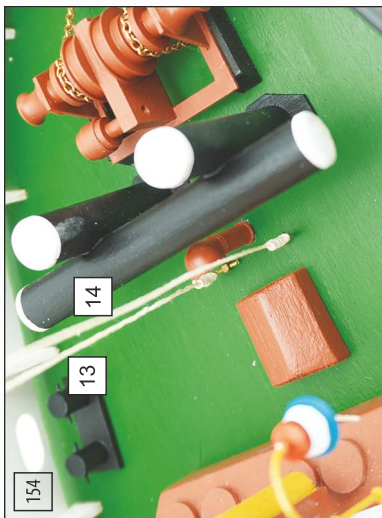

154

13

14

171

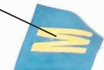

14

171



F121

13

14

13

171

F39

14

13

ZEELAND

willem muller

F1014



Template Photo 43 scale 1:1

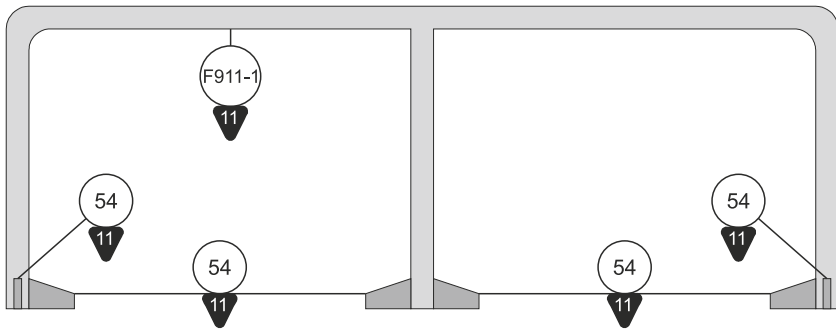

Template Photo 47 scale 1:1

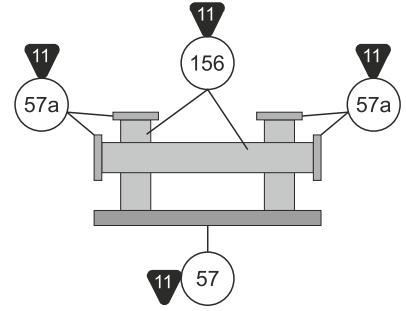

Template Photo 42 scale 1:1

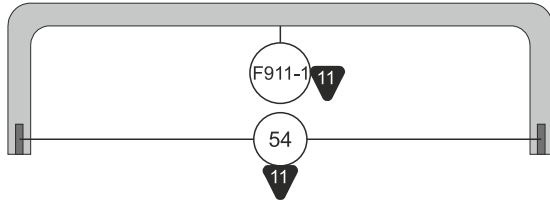

Template Photo 49 scale 1:1

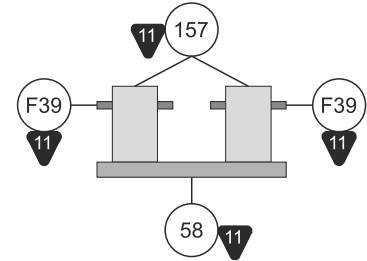

Template Photo 54 scale 1:1

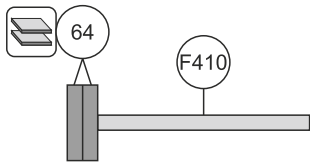
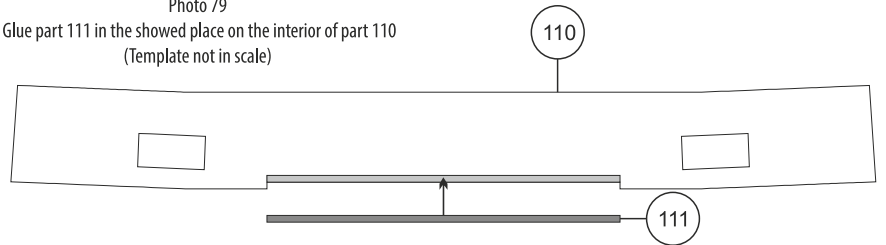
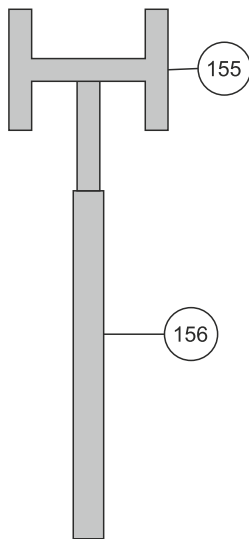

Photo 79  
Glue part 111 in the showed place on the interior of part 110  
(Template not in scale)



Template Photo 119 scale 1:1



Rudder casing template  
*cut to correct length*

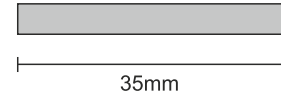

Rudder shaft template

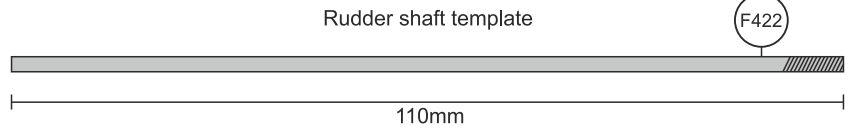

Propeller casing template  
*cut to correct length*

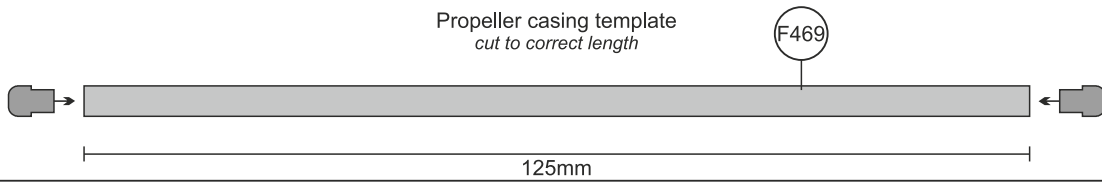

Propeller shaft template  
*cut to correct length*

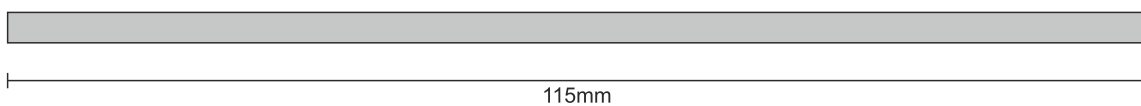













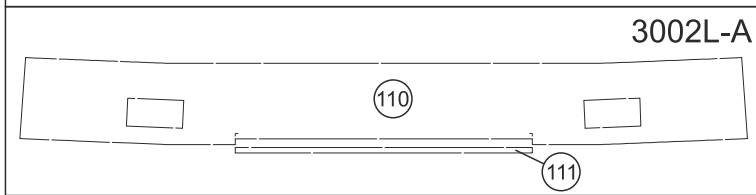
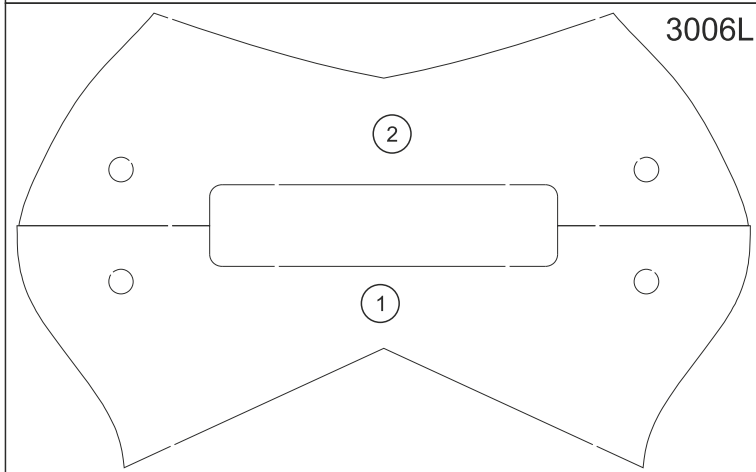
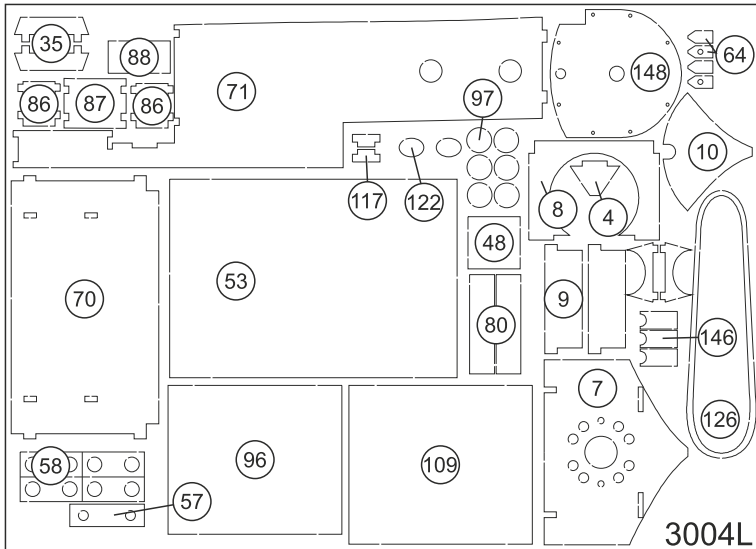

3005L

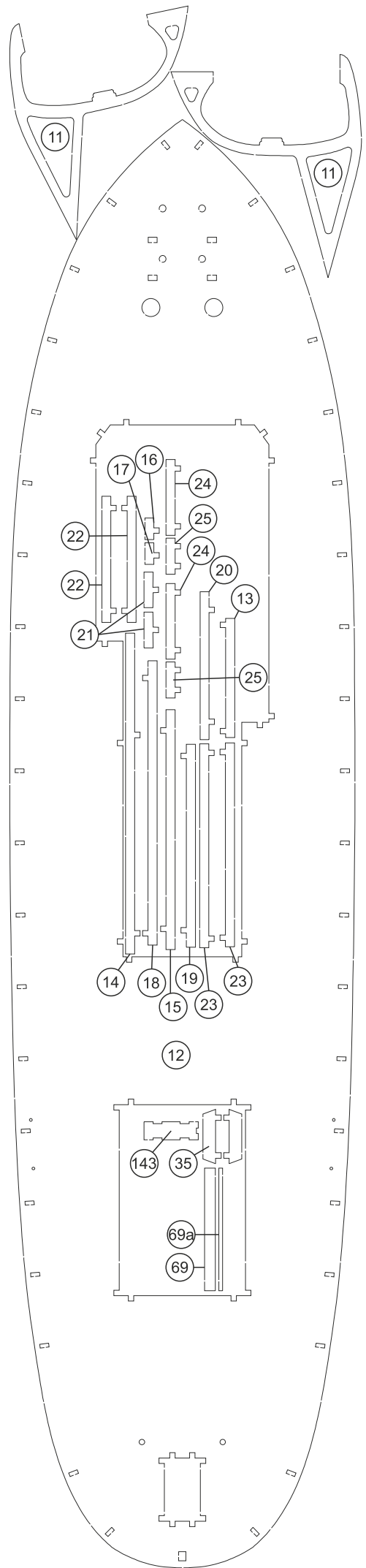



**Table of contents for Zeeland Art. No. 428**

<b>Pcs.</b>	<b>No.</b>	<b>Dimension</b>	<b>Material</b>	<b>Found In</b>	<b>DK</b>	<b>GB</b>	<b>D</b>	<b>F</b>	<b>NL</b>
1	P163	P163	PS		Skrog	Hull	Rumpf	Coque	Romp
1	1	5 mm x-veneér	3006L	LAS	Bundplade	Baseplate	Bodenplatte	Pièce de fond	Bodemplaat
1	2	5 mm x-veneér	3006L	LAS	Bundplade	Baseplate	Bodenplatte	Pièce de fond	Bodemplaat
1	3	2 mm x-veneér	3003L	LAS	RC Platform	RC Platform	RC Platform	RC Platform	RC Platform
1	4	2 mm x-veneér	3004L	LAS	RC Platform	RC Platform	RC Platform	RC Platform	RC Platform
1	5	2 mm x-veneér	3003L	LAS	RC Platform	RC Platform	RC Platform	RC Platform	RC Platform
2	6	2 mm x-veneér	3003L	LAS	RC Platform	RC Platform	RC Platform	RC Platform	RC Platform
1	7	2 mm x-veneér	3004L	LAS	RC Platform	RC Platform	RC Platform	RC Platform	RC Platform
1	8	2 mm x-veneér	3004L	LAS	RC Platform	RC Platform	RC Platform	RC Platform	RC Platform
2	9	2 mm x-veneér	3004L	LAS	RC Platform	RC Platform	RC Platform	RC Platform	RC Platform
1	10	2 mm x-veneér	3004L	LAS	Støtte	Support	Stütze	Support	Steun
2	11	3 mm x-veneér	3005L	LAS	Ror	Rudder	Ruder	Gouvernail	Roer
1	12	3 mm x-veneér	3005L	LAS	Dæk	Deck	Deck	Pont	Dek
1	13	3 mm x-veneér	3005L	LAS	Støtte	Support	Stütze	Support	Steun
1	14	3 mm x-veneér	3005L	LAS	Støtte	Support	Stütze	Support	Steun
1	15	3 mm x-veneér	3005L	LAS	Støtte	Support	Stütze	Support	Steun
1	16	3 mm x-veneér	3005L	LAS	Støtte	Support	Stütze	Support	Steun
1	17	3 mm x-veneér	3005L	LAS	Støtte	Support	Stütze	Support	Steun
1	18	3 mm x-veneér	3005L	LAS	Støtte	Support	Stütze	Support	Steun
1	19	3 mm x-veneér	3005L	LAS	Støtte	Support	Stütze	Support	Steun
1	20	3 mm x-veneér	3005L	LAS	Støtte	Support	Stütze	Support	Steun
2	21	3 mm x-veneér	3005L	LAS	Støtte	Support	Stütze	Support	Steun
2	22	3 mm x-veneér	3005L	LAS	Støtte	Support	Stütze	Support	Steun
2	23	3 mm x-veneér	3005L	LAS	Støtte	Support	Stütze	Support	Steun
2	24	3 mm x-veneér	3005L	LAS	Støtte	Support	Stütze	Support	Steun
2	25	3 mm x-veneér	3005L	LAS	Støtte	Support	Stütze	Support	Steun
4	26	2 mm x-veneér	3003L	LAS	Støtte	Support	Stütze	Support	Steun
10	26a	2 mm x-veneér	3003L	LAS	Støtte	Support	Stütze	Support	Steun
28	26b	2 mm x-veneér	3003L	LAS	Støtte	Support	Stütze	Support	Steun
2	27	1 mm x-veneér	3002L	LAS	Ræling	Railing	Reling	Bastingage	Reling
2	27a	1 mm x-veneér	3002L	LAS	Ræling	Railing	Reling	Bastingage	Reling
2	28	1 mm x-veneér	3002L	LAS	Ræling	Railing	Reling	Bastingage	Reling
14	29	1 mm x-veneér	3002L	LAS	Bogstaver	Letters	Buchstaben	Lettre	Brievren
24	30	1 mm x-veneér	3002L	LAS	Bogstaver	Letters	Buchstaben	Lettre	Brievren
16	31	1 mm x-veneér	3002L	LAS	Bogstaver	Letters	Buchstaben	Lettre	Brievren
1	32	1 mm x-veneér	3002L	LAS	Fender	Fender	Fender	Défence	Berghouten
1	33	1 mm x-veneér	3002L	LAS	Fender	Fender	Fender	Défence	Berghouten
1	34	1 mm x-veneér	3002L	LAS	Bundplade	Baseplate	Bodenplatte	Pièce de fond	Bodemplaat
2	35	3 mm x-veneér	3005L	LAS	Bundplade	Baseplate	Bodenplatte	Pièce de fond	Bodemplaat
2	35	3 mm x-veneér	3005L	LAS	Bundplade	Baseplate	Bodenplatte	Pièce de fond	Bodemplaat
1	36	1 mm x-veneér	3002L	LAS	Spil	Winch	Winde	Treuil	Winch
2	37	1 mm x-veneér	3002L	LAS	Spil	Winch	Winde	Treuil	Winch
2	38	2 mm x-veneér	3003L	LAS	Spil	Winch	Winde	Treuil	Winch
2	39	1 mm x-veneér	3002L	LAS	Bundplade	Baseplate	Bodenplatte	Pièce de fond	Bodemplaat
2	40	2 mm x-veneér	3003L	LAS	Støtte	Support	Stütze	Support	Steun
8	41	2 mm x-veneér	3003L	LAS	Støtte	Support	Stütze	Support	Steun
2	42	2 mm x-veneér	3003L	LAS	Luge	Hatch	Luke	Ecoutille	Luik
2	43	2 mm x-veneér	3003L	LAS	Luge	Hatch	Luke	Ecoutille	Luik
2	44	2 mm x-veneér	3003L	LAS	Luge	Hatch	Luke	Ecoutille	Luik
2	45	2 mm x-veneér	3003L	LAS	Luge	Hatch	Luke	Ecoutille	Luik
1	46	2 mm x-veneér	3003L	LAS	Luge	Hatch	Luke	Ecoutille	Luik

1	47	1 mm x-veneér	3002L	LAS	Luge	Hatch	Luke	Ecoutille	Luik
1	48	2 mm x-veneér	3004L	LAS	Luge	Hatch	Luke	Ecoutille	Luik
1	49	1 mm x-veneér	3002L	LAS	Luge	Hatch	Luke	Ecoutille	Luik
1	50	2 mm x-veneér	3003L	LAS	Luge	Hatch	Luke	Ecoutille	Luik
1	51	1 mm x-veneér	3002L	LAS	Luge	Hatch	Luke	Ecoutille	Luik
1	52	1 mm x-veneér	3002L	LAS	Luge	Hatch	Luke	Ecoutille	Luik
1	52a	2 mm x-veneér	3003L	LAS	Luge	Hatch	Luke	Ecoutille	Luik
1	53	2 mm x-veneér	3004L	LAS	Luge	Hatch	Luke	Ecoutille	Luik
4	54	1 mm x-veneér	3002L	LAS	Støtte	Support	Stütze	Support	Steun
8	55	1 mm x-veneér	3002L	LAS	Støtte	Support	Stütze	Support	Steun
2	56	1 mm x-veneér	3002L	LAS	Luge	Hatch	Luke	Ecoutille	Luik
1	57	2 mm x-veneér	3004L	LAS	Bundplade	Baseplate	Bodenplatte	Pièce de fond	Bodemplaat
4	57a	1 mm x-veneér	3002L	LAS	Pullert	Bollard	Poller	Bitte d'amarrage	Bolder
4	58	2 mm x-veneér	3004L	LAS	Bundplade	Baseplate	Bodenplatte	Pièce de fond	Bodemplaat
2	59	1 mm x-veneér	3002L	LAS	Lejder	Ladder	Leiter	Echelle	Ladder
2	59a	1 mm x-veneér	3002L	LAS	Lejder	Ladder	Leiter	Echelle	Ladder
4	60	1 mm x-veneér	3002L	LAS	Værktøjskasse	Tool box	Kisten	Caisse	Kist
8	61	1 mm x-veneér	3002L	LAS	Værktøjskasse	Tool box	Kisten	Caisse	Kist
8	62	1 mm x-veneér	3002L	LAS	Værktøjskasse	Tool box	Kisten	Caisse	Kist
24	63	1 mm x-veneér	3002L	LAS	Værktøj	Tools	Werkzeuge	Outils	Gereedschappen
4	64	2 mm x-veneér	3004L	LAS	Værktøj	Tools	Werkzeuge	Outils	Gereedschappen
2	65	1 mm x-veneér	3002L	LAS	Luge	Hatch	Luke	Ecoutille	Luik
1	66	1 mm x-veneér	3002L	LAS	Luge	Hatch	Luke	Ecoutille	Luik
2	67	1 mm x-veneér	3002L	LAS	Luge	Hatch	Luke	Ecoutille	Luik
2	68	1 mm x-veneér	3002L	LAS	Ror	Rudder	Ruder	Gouvernail	Roer
2	69	3 mm x-veneér	3005L	LAS	Ror	Rudder	Ruder	Gouvernail	Roer
1	70	2 mm x-veneér	3004L	LAS	Kahyt	Cabin	Kajüte	Cabine	Kajuit
1	71	2 mm x-veneér	3004L	LAS	Kahyt	Cabin	Kajüte	Cabine	Kajuit
1	71a	2 mm x-veneér	3003L	LAS	Kahyt	Cabin	Kajüte	Cabine	Kajuit
1	72	2 mm x-veneér	3003L	LAS	Kahyt	Cabin	Kajüte	Cabine	Kajuit
1	73	2 mm x-veneér	3003L	LAS	Kahyt	Cabin	Kajüte	Cabine	Kajuit
1	74	2 mm x-veneér	3003L	LAS	Kahyt	Cabin	Kajüte	Cabine	Kajuit
1	75	2 mm x-veneér	3003L	LAS	Kahyt	Cabin	Kajüte	Cabine	Kajuit
1	76	2 mm x-veneér	3003L	LAS	Kahyt	Cabin	Kajüte	Cabine	Kajuit
1	77	2 mm x-veneér	3003L	LAS	Kahyt	Cabin	Kajüte	Cabine	Kajuit
1	78	2 mm x-veneér	3003L	LAS	Kahyt	Cabin	Kajüte	Cabine	Kajuit
1	79	2 mm x-veneér	3003L	LAS	Kahyt	Cabin	Kajüte	Cabine	Kajuit
2	80	2 mm x-veneér	3004L	LAS	Kahyt	Cabin	Kajüte	Cabine	Kajuit
1	81	2 mm x-veneér	3003L	LAS	Kahyt	Cabin	Kajüte	Cabine	Kajuit
1	82	2 mm x-veneér	3003L	LAS	Kahyt	Cabin	Kajüte	Cabine	Kajuit
2	83	2 mm x-veneér	3003L	LAS	Kahyt	Cabin	Kajüte	Cabine	Kajuit
1	84	2 mm x-veneér	3003L	LAS	Kahyt	Cabin	Kajüte	Cabine	Kajuit
1	85	2 mm x-veneér	3003L	LAS	Kahyt	Cabin	Kajüte	Cabine	Kajuit
2	86	2 mm x-veneér	3004L	LAS	Kasse	Box	Kiste	Caisse	Kist
1	87	2 mm x-veneér	3004L	LAS	Kasse	Box	Kiste	Caisse	Kist
1	88	2 mm x-veneér	3004L	LAS	Kasse	Box	Kiste	Caisse	Kist
1	89	2 mm x-veneér	3003L	LAS	Dør	Door	Tür	Porte	Deur
1	90	2 mm x-veneér	3003L	LAS	Dør	Door	Tür	Porte	Deur
1	91	2 mm x-veneér	3003L	LAS	Dør	Door	Tür	Porte	Deur
1	92	2 mm x-veneér	3003L	LAS	Kahyt	Cabin	Kajüte	Cabine	Kajuit
1	93	2 mm x-veneér	3003L	LAS	Kahyt	Cabin	Kajüte	Cabine	Kajuit
2	94	2 mm x-veneér	3003L	LAS	Kahyt	Cabin	Kajüte	Cabine	Kajuit
1	95	2 mm x-veneér	3003L	LAS	Dør	Door	Tür	Porte	Deur
1	96	2 mm x-veneér	3003L	LAS	Dæk	Deck	Deck	Pont	Dek



Product Details			Material & Dimensions			Application & Location			Installation & Notes		
ID	Name	Material	Dimensions	Color	Finish	Part No.	Location	Notes	Quantity	Unit	Remarks
6	97	2 mm x-veneér	3004L	LAS	Luge	Hatch	Luke	Luik	1	Stander	Ecoutille
1	98	2 mm x-veneér	3004L	LAS	Dæk	Deck	Deck	Dek	2	Stander	Pont
2	99	2 mm x-veneér	3004L	LAS	Bedding	Bedding Slip	Helling	Cale de construction	1	Stander	Cale de construction
1	100	1 mm x-veneér	3002L	LAS	Støtte	Support	Stütze	Steun	2	Kajuit	Support
2	101	2 mm x-veneér	3003L	LAS	Kahyt	Cabin	Kajüte	Kajuit	2	Kajuit	Cabine
2	102	2 mm x-veneér	3003L	LAS	Kahyt	Cabin	Kajüte	Kajuit	2	Kajuit	Cabine
2	103	2 mm x-veneér	3003L	LAS	Kahyt	Cabin	Kajüte	Kajuit	2	Kajuit	Cabine
1	104	1 mm x-veneér	3002L	LAS	Instrumentbræt	Dashboard	Kajüte	Dashboard	1	Dashboard	Cloison
6	105	1 mm x-veneér	3002L	LAS	Instrumentbræt	Dashboard	Instrumentbrett	Dashboard	6	Dashboard	Cloison
1	106	1 mm x-veneér	3002L	LAS	Rat	Steering wheel	Lenkrad	Stuur	1	Stuur	Volant
2	107	1 mm x-veneér	3002L	LAS	Rat	Steering wheel	Lenkrad	Stuur	2	Stuur	Volant
2	108	1 mm x-veneér	3002L	LAS	Rat	Steering wheel	Lenkrad	Stuur	2	Stuur	Volant
1	109	2 mm x-veneér	3004L	LAS	Tag	Roof	Dach	Dak	1	Dak	Toit
1	110	1 mm x-veneér	3002L-A	LAS	Gelænder	Rail	Gelænder	Reling	1	Reling	Bastingage
1	111	1 mm x-veneér	3002L-A	LAS	Gelænder	Rail	Gelænder	Reling	1	Reling	Bastingage
1	112	2 mm x-veneér	3003L	LAS	Gelænder	Rail	Gelænder	Reling	1	Reling	Bastingage
2	113	1 mm x-veneér	3002L	LAS	Lanterne	Light	Lanterne	Boordlichten	2	Boordlichten	Feux
4	114	1 mm x-veneér	3002L	LAS	Lanterne	Light	Lanterne	Boordlichten	4	Boordlichten	Feux
2	115	1 mm x-veneér	3002L	LAS	Lanterne	Light	Lanterne	Boordlichten	2	Boordlichten	Feux
2	116	1 mm x-veneér	3002L	LAS	Lanterne	Light	Lanterne	Boordlichten	2	Boordlichten	Feux
2	117	2 mm x-veneér	3004L	LAS	Støtte	Support	Stütze	Steun	2	Steun	Support
1	118	1 mm x-veneér	3002L	LAS	Støtte	Support	Stütze	Steun	1	Steun	Support
1	119	2 mm x-veneér	3003L	LAS	Støtte	Support	Stütze	Steun	1	Steun	Support
1	120	1 mm x-veneér	3002L	LAS	Bedding	Bedding Slip	Helling	Cale de construction	1	Stander	Cale de construction
1	121	1 mm x-veneér	3002L	LAS	Bedding	Bedding Slip	Helling	Cale de construction	1	Stander	Cale de construction
2	122	2 mm x-veneér	3004L	LAS	Kahyt	Cabin	Kajüte	Kajuit	2	Kajuit	Cabine
2	123	1 mm x-veneér	3002L	LAS	Skorsten	Chimney	Schorstein	Schoorsteen	2	Schoorsteen	Cheminée
14	124	1 mm x-veneér	3002L	LAS	Skorsten	Chimney	Schorstein	Schoorsteen	14	Schoorsteen	Cheminée
2	125	1 mm x-veneér	3002L	LAS	Radar	Radar	Radar	Radar	2	Radar	Radar
1	126	2 mm x-veneér	3004L	LAS	Skorstensbund	Chimney base	Schorsteinbasis	Schoorsteen	1	Schoorsteen	Base de cheminée
2	127	1 mm x-veneér	3002L	LAS	Støtte	Support	Stütze	Steun	2	Steun	Support
2	128	2 mm x-veneér	3003L	LAS	Trappe	Stair	Treppe	Trap	2	Trap	Escalier
10	129	1 mm x-veneér	3002L	LAS	Trappetrin	Stair step	Treppe schritt	Trap step	10	Trap	Escaliers
1	130	1 mm x-veneér	3002L	LAS	Lister	Strips	Leisten	Strips	1	Strips	Baguettes
1	131	1 mm x-veneér	3002L	LAS	Lister	Strips	Leisten	Strips	1	Strips	Baguettes
1	132	1 mm x-veneér	3002L	LAS	Lister	Strips	Leisten	Strips	1	Strips	Baguettes
1	133	1 mm x-veneér	3002L	LAS	Lister	Strips	Leisten	Strips	1	Strips	Baguettes
1	134	1 mm x-veneér	3002L	LAS	Lister	Strips	Leisten	Strips	1	Strips	Baguettes
1	135	1 mm x-veneér	3002L	LAS	Lister	Strips	Leisten	Strips	1	Strips	Baguettes
1	136	1 mm x-veneér	3002L	LAS	Lister	Strips	Leisten	Strips	1	Strips	Baguettes
1	137	1 mm x-veneér	3002L	LAS	Lister	Strips	Leisten	Strips	1	Strips	Baguettes
2	138	1 mm x-veneér	3002L	LAS	Spil	Winch	Winde	Winch	2	Winch	Treuil
1	139	1 mm x-veneér	3002L	LAS	Spil	Winch	Winde	Winch	1	Winch	Treuil
2	140	1 mm x-veneér	3002L	LAS	Spil	Winch	Winde	Winch	2	Winch	Treuil
1	141	1 mm x-veneér	3002L	LAS	Spil	Winch	Winde	Winch	1	Winch	Treuil
2	142	1 mm x-veneér	3002L	LAS	Spil	Winch	Winde	Winch	2	Winch	Treuil
1	143	3 mm x-veneér	3005L	LAS	Støtte	Support	Stütze	Steun	1	Steun	Support
2	144	1 mm x-veneér	3002L	LAS	Støtte	Support	Stütze	Steun	2	Steun	Support
1	145	1 mm x-veneér	3002L	LAS	Støtte	Support	Stütze	Steun	1	Steun	Support
3	146	2 mm x-veneér	3004L	LAS	Støtte	Support	Stütze	Steun	3	Steun	Support
2	147	1 mm x-veneér	3002L	LAS	Støtte	Support	Stütze	Steun	2	Steun	Support
1	148	2 mm x-veneér	3004L	LAS	Bundplade	Baseplate	Bodenplatte	Bodemplaat	1	Bodemplaat	Pièce de fond
1	149	2 mm x-veneér	3003L	LAS	Bundplade	Baseplate	Bodenplatte	Bodemplaat	1	Bodemplaat	Pièce de fond
1	150	1 mm x-veneér	3002L	LAS	Lister	Strips	Leisten	Strips	1	Strips	Baguettes





2	F418	ø10x9mm	Brass	BF-B	Lanterne	Light	Lanternen	Feux	Boordlichten
2	F419	ø10x3mm	Plastic	BF-A	Lanterne	Light	Lanternen	Feux	Boordlichten
4	F420	ø1,5x5mm	Brass	BF-B	Stifte	Pins	Stifte	Clous	Spijkertjes
1	F422	ø3x118mm	Brass	MS	Roraksel	Rudder shaft	Ruderwelle	Arbre du gouvernail	Roeras
1	F423	ø4x35mm	Brass	BF2	Ror	Rudder	Ruder	Gouvernail	Roer
1	F450	ø8x12mm	Brass	BF-B	Spil	Winch	Winde	Treuil	Winch
3	F459	ø6x7,5mm	Brass	BF-A, BF-D	Lanterne	Light	Lanternen	Feux	Boordlichten
1	F469	ø5x170mm	Brass	MS, BF-C	Propelaksel	Propeller shaft	Stevenrohr	Arbre porte hélice	Schroefas
4	F488	ø3mm	Plastic	BF-A	Kugle	Ball	Kugel	Boule	Bal
3	F537	25mm	Brass	BF-C	Plade ved røstjern	Chain plate	Platte f. Nagelbank	Plan. p. fixation	Versterking putting
5	F539	40mm	Brass	BF-B	Plade ved røstjern	Chain plate	Platte f. Nagelbank	Plan. p. fixation	Versterking putting
1	F595	ø6x4mm	Brass	BF-D	Ventil	Vent	Lüfter	Manche à air	Luchtloker
2	F626	18mm	Brass	BF-C	Ventil	Vent	Lüfter	Manche à air	Luchtloker
16	F627	31mm	Brass	BF-D	Gelænderstøtte	Rail stanchion	Relingstøtze	Chandelier	Railingpaal
1	F629	ø14,5x10mm	Brass	BF-C	Tromle	Drum	Trommel	Tambouriner	Trommel
2	F637	ø8x12mm	Brass	BF-D	Sirene	Siren	Sirene	Sirène	Sirene
1	F643	ø10x9,5mm	Brass	BF-C	Klokke	Bell	Glocke	Cloche	Scheepbel
2	F651	ø7mm	Plastic	BF-A	Håndhjul	Handwheel	Sternrad	Roue à main	Handwiel
6	F655	ø28mm	Rubber	BF-D	Dæk	Tire	Reifen	Pneu	Wielband
2	F658	ø5x6mm	Brass	BF-B	Lanterne	Light	Lanternen	Feux	Boordlichten
9	F664	11mm	Brass	BF-C	Øjebolt	Eyebolt	Ringschraube	Anneau à visser	Oogbout
1	F677	ø7x5mm	Brass	BF-C	Tromle	Drum	Trommel	Tambouriner	Trommel
3	F717	22mm	Brass	BF-B	Lanterne	Light	Lanternen	Feux	Boordlichten
3	F795	200mm	Wire	MS	Slange	Hose	Schlauch	Tuyau	Slang
1	F804	15x120mm	Rubber	MS	Fender	Fender	Fender	Défence	Berghouten
2	F911-1	ø3x250mm	Alu	MS	Aluminiumstråd	Aluminium wire	Aluminiumdraht	Fil d'aluminium	Aluminiumdraad
1	F958	13x31mm	Resin	BF-A	Motor	Motor	Motor	Moteur	Motor
1	F1007	ø30x4,5mm	Wood	BF-A	Rat	Wheel	Steuerrad	Roue	Stuurwiel
1	F1014	50mm	Brass	BF-D	Skibsskrue	Propeller	Schiffsschraube	Hélice	Scheepsschroef
2	F1016	19mm	Resin	BF-A	Propel support	Propeller support	Propellerunterstützung	Support d'hélice	Propellerondersteuning
1	F1017	58mm	Resin	BF-A	Krog	Hook	Haken	Accrocher	Haak
1	F1018	ø4x13mm	Resin	BF-A	Krog	Hook	Haken	Accrocher	Haak
1	F1019	11x14mm	Resin	BF-A	Radar	Radar	Radar	Radar	Radar
1	F1020	11mm	Resin	BF-A	Lanterne	Light	Lanternen	Feux	Boordlichten

**Table of contents for Zealand Art. No. 428**

<b>Pcs.</b>	<b>No.</b>	<b>Dimension</b>	<b>Material</b>	<b>Found In</b>	<b>E</b>	<b>I</b>	<b>P</b>	<b>PL</b>
1	P163		PS		Casco	Scafo	Casco	Kadlub
1	1	5 mm x-veneér	3006L	LAS	Placa de fondo	Lastra di fondo	Placa de fundo	Podstawa
1	2	5 mm x-veneér	3006L	LAS	Placa de fondo	Lastra di fondo	Placa de fundo	Podstawa
1	3	2 mm x-veneér	3003L	LAS	RC Platform	RC Platform	RC Platform	RC Platform
1	4	2 mm x-veneér	3004L	LAS	RC Platform	RC Platform	RC Platform	RC Platform
1	5	2 mm x-veneér	3003L	LAS	RC Platform	RC Platform	RC Platform	RC Platform
2	6	2 mm x-veneér	3003L	LAS	RC Platform	RC Platform	RC Platform	RC Platform
1	7	2 mm x-veneér	3004L	LAS	RC Platform	RC Platform	RC Platform	RC Platform
1	8	2 mm x-veneér	3004L	LAS	RC Platform	RC Platform	RC Platform	RC Platform
2	9	2 mm x-veneér	3004L	LAS	RC Platform	RC Platform	RC Platform	RC Platform
1	10	2 mm x-veneér	3004L	LAS	Soporte	Supporto	Supporte	Wspornik
2	11	3 mm x-veneér	3005L	LAS	Timón	Timone	Leme	Ster
1	12	3 mm x-veneér	3005L	LAS	Cubierta	Ponte	Convés	Poklad
1	13	3 mm x-veneér	3005L	LAS	Soporte	Supporto	Supporte	Wspornik
1	14	3 mm x-veneér	3005L	LAS	Soporte	Supporto	Supporte	Wspornik
1	15	3 mm x-veneér	3005L	LAS	Soporte	Supporto	Supporte	Wspornik
1	16	3 mm x-veneér	3005L	LAS	Soporte	Supporto	Supporte	Wspornik
1	17	3 mm x-veneér	3005L	LAS	Soporte	Supporto	Supporte	Wspornik
1	18	3 mm x-veneér	3005L	LAS	Soporte	Supporto	Supporte	Wspornik
1	19	3 mm x-veneér	3005L	LAS	Soporte	Supporto	Supporte	Wspornik
1	20	3 mm x-veneér	3005L	LAS	Soporte	Supporto	Supporte	Wspornik
2	21	3 mm x-veneér	3005L	LAS	Soporte	Supporto	Supporte	Wspornik
2	22	3 mm x-veneér	3005L	LAS	Soporte	Supporto	Supporte	Wspornik
2	23	3 mm x-veneér	3005L	LAS	Soporte	Supporto	Supporte	Wspornik
2	24	3 mm x-veneér	3005L	LAS	Soporte	Supporto	Supporte	Wspornik
2	25	3 mm x-veneér	3005L	LAS	Soporte	Supporto	Supporte	Wspornik
4	26	2 mm x-veneér	3003L	LAS	Soporte	Supporto	Supporte	Wspornik
10	26a	2 mm x-veneér	3003L	LAS	Soporte	Supporto	Supporte	Wspornik
28	26b	2 mm x-veneér	3003L	LAS	Soporte	Supporto	Supporte	Wspornik
2	27	1 mm x-veneér	3002L	LAS	Barrandilla	Parapetto di murata	Corrimão	Poręcz
2	27a	1 mm x-veneér	3002L	LAS	Barrandilla	Parapetto di murata	Corrimão	Poręcz
2	28	1 mm x-veneér	3002L	LAS	Barrandilla	Parapetto di murata	Corrimão	Poręcz
14	29	1 mm x-veneér	3002L	LAS	Letras	Lettere	Cartas	Litery
24	30	1 mm x-veneér	3002L	LAS	Letras	Lettere	Cartas	Litery
16	31	1 mm x-veneér	3002L	LAS	Letras	Lettere	Cartas	Litery
1	32	1 mm x-veneér	3002L	LAS	Como de cojin	Parabordo	Defensa	Zdenrzak
1	33	1 mm x-veneér	3002L	LAS	Como de cojin	Parabordo	Defensa	Zdenrzak
1	34	1 mm x-veneér	3002L	LAS	Placa de fondo	Lastra di fondo	Placa de fundo	Podstawa
2	35	3 mm x-veneér	3005L	LAS	Placa de fondo	Lastra di fondo	Placa de fundo	Podstawa
2	35	3 mm x-veneér	3005L	LAS	Placa de fondo	Lastra di fondo	Placa de fundo	Podstawa
1	36	1 mm x-veneér	3002L	LAS	Chigre	Verricello, Arganello	Guincho	Wciążarka
2	37	1 mm x-veneér	3002L	LAS	Chigre	Verricello, Arganello	Guincho	Wciążarka
2	38	2 mm x-veneér	3003L	LAS	Chigre	Verricello, Arganello	Guincho	Wciążarka
2	39	1 mm x-veneér	3002L	LAS	Placa de fondo	Lastra di fondo	Placa de fundo	Podstawa
2	40	2 mm x-veneér	3003L	LAS	Soporte	Supporto	Supporte	Wspornik
8	41	2 mm x-veneér	3003L	LAS	Soporte	Supporto	Supporte	Wspornik
2	42	2 mm x-veneér	3003L	LAS	Escotilla	Bocaporto	Escotilha	Właz
2	43	2 mm x-veneér	3003L	LAS	Escotilla	Bocaporto	Escotilha	Właz
2	44	2 mm x-veneér	3003L	LAS	Escotilla	Bocaporto	Escotilha	Właz
2	45	2 mm x-veneér	3003L	LAS	Escotilla	Bocaporto	Escotilha	Właz
1	46	2 mm x-veneér	3003L	LAS	Escotilla	Bocaporto	Escotilha	Właz



1	47	1 mm x-veneér	3002L	LAS	Escotilla	Boccaporto	Escotilha	Escotilha	Wlaz
1	48	2 mm x-veneér	3004L	LAS	Escotilla	Boccaporto	Escotilha	Escotilha	Wlaz
1	49	1 mm x-veneér	3002L	LAS	Escotilla	Boccaporto	Escotilha	Escotilha	Wlaz
1	50	2 mm x-veneér	3003L	LAS	Escotilla	Boccaporto	Escotilha	Escotilha	Wlaz
1	51	1 mm x-veneér	3002L	LAS	Escotilla	Boccaporto	Escotilha	Escotilha	Wlaz
1	52	1 mm x-veneér	3002L	LAS	Escotilla	Boccaporto	Escotilha	Escotilha	Wlaz
1	52a	2 mm x-veneér	3003L	LAS	Escotilla	Boccaporto	Escotilha	Escotilha	Wlaz
1	53	2 mm x-veneér	3004L	LAS	Escotilla	Boccaporto	Escotilha	Escotilha	Wlaz
4	54	1 mm x-veneér	3002L	LAS	Soporte	Supporto	Suporte	Supornik	Wspornik
8	55	1 mm x-veneér	3002L	LAS	Soporte	Supporto	Suporte	Supornik	Wspornik
2	56	1 mm x-veneér	3002L	LAS	Escotilla	Boccaporto	Escotilha	Wlaz	Wlaz
1	57	2 mm x-veneér	3004L	LAS	Placa de fondo	Lastra di fondo	Placa de fundo	Podstawa	Podstawa
4	57a	1 mm x-veneér	3002L	LAS	Bolardo	Bitta	Poste de amarração	Pacholek	Pacholek
4	58	2 mm x-veneér	3004L	LAS	Placa de fondo	Lastra di fondo	Placa de fundo	Podstawa	Podstawa
2	59	1 mm x-veneér	3002L	LAS	Escalera	Scaletta	Escada	Drabina	Drabina
2	59a	1 mm x-veneér	3002L	LAS	Escalera	Scaletta	Escada	Drabina	Drabina
4	60	1 mm x-veneér	3002L	LAS	Caja	Cassa	Baú	Skrzynka	Skrzynka
8	61	1 mm x-veneér	3002L	LAS	Caja	Cassa	Baú	Skrzynka	Skrzynka
8	62	1 mm x-veneér	3002L	LAS	Caja	Cassa	Baú	Skrzynka	Skrzynka
24	63	1 mm x-veneér	3002L	LAS	Herramientas	Strumenti	Ferramentas	Narzędzia	Narzędzia
4	64	2 mm x-veneér	3004L	LAS	Herramientas	Strumenti	Ferramentas	Narzędzia	Narzędzia
2	65	1 mm x-veneér	3002L	LAS	Escotilla	Boccaporto	Escotilha	Wlaz	Wlaz
1	66	1 mm x-veneér	3002L	LAS	Escotilla	Boccaporto	Escotilha	Wlaz	Wlaz
2	67	1 mm x-veneér	3002L	LAS	Escotilla	Boccaporto	Escotilha	Wlaz	Wlaz
2	68	1 mm x-veneér	3002L	LAS	Timón	Timone	Leme	Ster	Ster
2	69	3 mm x-veneér	3005L	LAS	Timón	Timone	Leme	Ster	Ster
1	70	2 mm x-veneér	3004L	LAS	Camarote	Cabina	Cabine	Kabina	Kabina
1	71	2 mm x-veneér	3004L	LAS	Camarote	Cabina	Cabine	Kabina	Kabina
1	71a	2 mm x-veneér	3003L	LAS	Camarote	Cabina	Cabine	Kabina	Kabina
1	72	2 mm x-veneér	3003L	LAS	Camarote	Cabina	Cabine	Kabina	Kabina
1	73	2 mm x-veneér	3003L	LAS	Camarote	Cabina	Cabine	Kabina	Kabina
1	74	2 mm x-veneér	3003L	LAS	Camarote	Cabina	Cabine	Kabina	Kabina
1	75	2 mm x-veneér	3003L	LAS	Camarote	Cabina	Cabine	Kabina	Kabina
1	76	2 mm x-veneér	3003L	LAS	Camarote	Cabina	Cabine	Kabina	Kabina
1	77	2 mm x-veneér	3003L	LAS	Camarote	Cabina	Cabine	Kabina	Kabina
1	78	2 mm x-veneér	3003L	LAS	Camarote	Cabina	Cabine	Kabina	Kabina
1	79	2 mm x-veneér	3003L	LAS	Camarote	Cabina	Cabine	Kabina	Kabina
2	80	2 mm x-veneér	3004L	LAS	Camarote	Cabina	Cabine	Kabina	Kabina
1	81	2 mm x-veneér	3003L	LAS	Camarote	Cabina	Cabine	Kabina	Kabina
1	82	2 mm x-veneér	3003L	LAS	Camarote	Cabina	Cabine	Kabina	Kabina
2	83	2 mm x-veneér	3003L	LAS	Camarote	Cabina	Cabine	Kabina	Kabina
1	84	2 mm x-veneér	3003L	LAS	Camarote	Cabina	Cabine	Kabina	Kabina
1	85	2 mm x-veneér	3003L	LAS	Camarote	Cabina	Cabine	Kabina	Kabina
2	86	2 mm x-veneér	3004L	LAS	Caja	Cassa	Caixa	Skrzynia	Skrzynia
1	87	2 mm x-veneér	3004L	LAS	Caja	Cassa	Caixa	Skrzynia	Skrzynia
1	88	2 mm x-veneér	3004L	LAS	Caja	Cassa	Caixa	Skrzynia	Skrzynia
1	89	2 mm x-veneér	3003L	LAS	Puerta	Porta	Porta	Drzwi	Drzwi
1	90	2 mm x-veneér	3003L	LAS	Puerta	Porta	Porta	Drzwi	Drzwi
1	91	2 mm x-veneér	3003L	LAS	Puerta	Porta	Porta	Drzwi	Drzwi
1	92	2 mm x-veneér	3003L	LAS	Camarote	Cabina	Cabine	Kabina	Kabina
1	93	2 mm x-veneér	3003L	LAS	Camarote	Cabina	Cabine	Kabina	Kabina
2	94	2 mm x-veneér	3003L	LAS	Camarote	Cabina	Cabine	Kabina	Kabina
1	95	2 mm x-veneér	3003L	LAS	Puerta	Porta	Porta	Drzwi	Drzwi
1	96	2 mm x-veneér	3003L	LAS	Cubierta	Ponte	Convés	Pokład	Pokład

6	97	2 mm x-veneér	3004L	LAS	Escotilha	Bocaporto	Escotilha	Wiaz
1	98	2 mm x-veneér	3004L	LAS	Cubierta	Ponte	Convés	Poklad
2	99	2 mm x-veneér	3004L	LAS	Soporte	Soporte	Soporte para o casco	Podstawka
1	100	1 mm x-veneér	3002L	LAS	Soporte	Soporte	Soporte	Wspornik
2	101	2 mm x-veneér	3003L	LAS	Camarote	Cabina	Cabine	Kabina
2	102	2 mm x-veneér	3003L	LAS	Camarote	Cabina	Cabine	Kabina
2	103	2 mm x-veneér	3003L	LAS	Camarote	Cabina	Cabine	Kabina
1	104	1 mm x-veneér	3002L	LAS	Tabla de instrumentos	Porta-strumenti	Painel de instrumentos	Panel
6	105	1 mm x-veneér	3002L	LAS	Tabla de instrumentos	Porta-strumenti	Painel de instrumentos	Panel
1	106	1 mm x-veneér	3002L	LAS	Volante	Volante	Volante	Koto sterowe
2	107	1 mm x-veneér	3002L	LAS	Volante	Volante	Volante	Koto sterowe
2	108	1 mm x-veneér	3002L	LAS	Volante	Volante	Volante	Koto sterowe
1	109	2 mm x-veneér	3004L	LAS	Techo	Techo	Teto	Dach
1	110	1 mm x-veneér	3002L-A	LAS	Pasamanos	Ringhiera	Amurada	Reling
1	111	1 mm x-veneér	3002L-A	LAS	Pasamanos	Ringhiera	Amurada	Reling
1	112	2 mm x-veneér	3003L	LAS	Pasamanos	Ringhiera	Amurada	Reling
2	113	1 mm x-veneér	3002L	LAS	Linternas	Lanterna di bordo	Luzes	Lampa
4	114	1 mm x-veneér	3002L	LAS	Linternas	Lanterna di bordo	Luzes	Lampa
2	115	1 mm x-veneér	3002L	LAS	Linternas	Lanterna di bordo	Luzes	Lampa
2	116	1 mm x-veneér	3002L	LAS	Linternas	Lanterna di bordo	Luzes	Lampa
2	117	2 mm x-veneér	3004L	LAS	Soporte	Soporte	Soporte	Wspornik
1	118	1 mm x-veneér	3002L	LAS	Soporte	Soporte	Soporte	Wspornik
1	119	2 mm x-veneér	3003L	LAS	Soporte	Soporte	Soporte	Wspornik
1	120	1 mm x-veneér	3002L	LAS	Soporte	Soporte	Soporte para o casco	Podstawka
1	121	1 mm x-veneér	3002L	LAS	Soporte	Soporte	Soporte para o casco	Podstawka
2	122	2 mm x-veneér	3004L	LAS	Camarote	Cabina	Cabine	Kabina
2	123	1 mm x-veneér	3002L	LAS	Chimenea	Ciminiera	Chaminé	Komin
14	124	1 mm x-veneér	3002L	LAS	Chimenea	Ciminiera	Chaminé	Komin
2	125	1 mm x-veneér	3002L	LAS	Radar	Radar	Radar	Radar
1	126	2 mm x-veneér	3004L	LAS	Base de chimenea	Base del camino	Chimney-Base	Komin
2	127	1 mm x-veneér	3002L	LAS	Soporte	Soporte	Soporte	Wspornik
2	128	2 mm x-veneér	3003L	LAS	Escalera	Scaletta	Escada	Schody
10	129	1 mm x-veneér	3002L	LAS	Escalera paso	Stair passo	Degrau de escada	Stoپیeń
1	130	1 mm x-veneér	3002L	LAS	Listón	Listello	Tiras	Listwa
1	131	1 mm x-veneér	3002L	LAS	Listón	Listello	Tiras	Listwa
1	132	1 mm x-veneér	3002L	LAS	Listón	Listello	Tiras	Listwa
1	133	1 mm x-veneér	3002L	LAS	Listón	Listello	Tiras	Listwa
1	134	1 mm x-veneér	3002L	LAS	Listón	Listello	Tiras	Listwa
1	135	1 mm x-veneér	3002L	LAS	Listón	Listello	Tiras	Listwa
1	136	1 mm x-veneér	3002L	LAS	Listón	Listello	Tiras	Listwa
1	137	1 mm x-veneér	3002L	LAS	Listón	Listello	Tiras	Listwa
2	138	1 mm x-veneér	3002L	LAS	Chigre	Verricello, Arganello	Guincho	Listwa
1	139	1 mm x-veneér	3002L	LAS	Chigre	Verricello, Arganello	Guincho	Listwa
2	140	1 mm x-veneér	3002L	LAS	Chigre	Verricello, Arganello	Guincho	Wciagarka
1	141	1 mm x-veneér	3002L	LAS	Chigre	Verricello, Arganello	Guincho	Wciagarka
2	142	1 mm x-veneér	3002L	LAS	Chigre	Verricello, Arganello	Guincho	Wciagarka
1	143	3 mm x-veneér	3005L	LAS	Soporte	Soporte	Soporte	Wspornik
2	144	1 mm x-veneér	3002L	LAS	Soporte	Soporte	Soporte	Wspornik
1	145	1 mm x-veneér	3002L	LAS	Soporte	Soporte	Soporte	Wspornik
3	146	2 mm x-veneér	3004L	LAS	Soporte	Soporte	Soporte	Wspornik
2	147	1 mm x-veneér	3002L	LAS	Soporte	Soporte	Soporte	Wspornik
1	148	2 mm x-veneér	3004L	LAS	Placa de fondo	Lastra di fondo	Placa de fundo	Podstawka
1	149	2 mm x-veneér	3003L	LAS	Placa de fondo	Lastra di fondo	Placa de fundo	Podstawka
1	150	1 mm x-veneér	3002L	LAS	Listón	Listello	Tiras	Listwa

4	151	1 mm x-veneér	3002L	LAS	Cañon de agua	Cannone acquatico	Canhão de água	Armatka wodna
2	152	1 mm x-veneér	3002L	LAS	Cañon de agua	Cannone acquatico	Canhão de água	Armatka wodna
2	153	1 mm x-veneér	3002L	LAS	Cañon de agua	Cannone acquatico	Canhão de água	Armatka wodna
1	154	1 mm x-veneér	3002L	LAS	Soporte	Supporto	Supporte	Wspornik
1	155	ø3x70mm	Basswood	TS	Palo redondo	Bastone rotondo	Bastão redondo	Kij okragly
1	156	ø4x300mm	Basswood	TS	Palo redondo	Bastone rotondo	Bastão redondo	Kij okragly
7	157	ø6x250mm	Basswood	TS	Palo redondo	Bastone rotondo	Bastão redondo	Kij okragly
1	158	ø8x400mm	Basswood	LB	Palo redondo	Bastone rotondo	Bastão redondo	Kij okragly
1	159	ø10x300mm	Basswood	TS	Palo redondo	Bastone rotondo	Bastão redondo	Kij okragly
1	160	ø12x200mm	Basswood	TS	Palo redondo	Bastone rotondo	Bastão redondo	Kij okragly
1	161	3x2000mm	PS	Como de cojín	Como de cojín	Parabordo	Defensa	Zdenrzak
1	162	9x16x20mm	Basswood	TS	Bloque	Blocco	Bloco	Blok
1	163	60x130mm	Acetate	VEJ	Acetate	Acetato	Acetato	Folia
1	164	P164	PS	Bañera	Bañera	Poppetta	Cabine de comando	Kokpit
1	165	P164	PS	Bañera	Bañera	Poppetta	Cabine de comando	Kokpit
2	166	P164	PS	Chimenea	Chimenea	Ciminiera	Chaminé	Komin
2	167	P164	PS	Bote salvavidas	Bote salvavidas	Battello di salvataggio	Barco salva-vidas	Szalupa
2	168	P164	PS	Bote salvavidas	Bote salvavidas	Battello di salvataggio	Barco salva-vidas	Szalupa
3	169	0,7x3x550mm	Annegré	LB	Listón	Listello	Tira	Listwa
4	170	0,7x3x550mm	Mahogany	LB	Listón	Listello	Tira	Listwa
1	171		FL 134	VEJ	Bandera	Bandiera	Bandeira	Flaga
1				VEJ	El dibujo	Disegno	Desenho	Rysunek
1		A4		VEJ	Instrucciones de montaje	Istruzioni di montaggio	Instruções de montagem	Instrukcja budowy
4	F24	20mm	Plastic	BF-A	Cinturones salvavidas	Scialuppa da salvataggio	Bote salv-vida	Kolo ratunkowe
2	F25	ø16x14mm	Brass	BF-B	Tambor	Tamburo	Tambor	Bèben
2	F28	ø7x33mm	Plastic	BF-A	Válvula	Valvola	Respiradouro	Wentylacja
2	F37	15mm	Plastic	BF-A	Ancla	Ancora	Âncora	Kotwica
5	F39	ø1,0x250mm	Brass	MS	Hilo de latón	Filo in ottone	Fio de latão	Drut
1	F60	ø5x20mm	Plastic	BF-A	Válvula	Valvola	Respiradouro	Wentylacja
2	F63	ø5x2,25mm	Brass	BF-B	Chigre	Verricello, Arganello	Guincho	Wciągarka
5	F65	ø10mm	Brass	BF-B	Portilla	Oblò	Luz de bombordo	Bulaj
2	F66	ø6mm	Plastic	BF-A	Portilla	Oblò	Luz de bombordo	Bulaj
1	F71	10 m		TS	Soga	Corda	Corda	Lina
1	F72	10 m		TS	Soga	Corda	Corda	Lina
1	F73	3 m		TS	Soga	Corda	Corda	Lina
1	F76	ø2,5x350mm	Brass	BF-D	Cadena	Catena	Corrente	Łańcuch
1	F78	ø6x9,5mm	Brass	BF-B	Chigre	Verricello, Arganello	Guincho	Wciągarka
5	F121	ø6x7,5mm	Brass	BF-D	Linternas	Lanterna di bordo	Luzes	Lampa
2	F135	ø6x10mm	Brass	BF-C	Bolardo	Bitta	Poste de amarração	Pachotek
2	F137	ø10x8mm	Brass	BF-B	Fin de deformación	Fine deformata	Encerrior	Zakończenie
13	F190	ø3,8mm	Brass	BF-C	Escobén	Passacavo	Tubarão hawse	Prowadnica
6	F204	7mm	Metal	BF-C	Escalera	Scaletta	Escada	Drabina
29	F206	12mm	Metal	BF-D	Escalera	Scaletta	Escada	Drabina
4	F222	7mm	Plastic	BF-A	Bloque	Blocco	Bloco	Blok
1	F264	10x13,5mm	Brass	BF-D	Chigre	Verricello, Arganello	Guincho	Wciągarka
10	F285	ø2x5,5mm	Brass	BF-D	Cáncamo	Occhio	Olhal	Śruba oczkowa
1	F317	ø4x2mm	Brass	BF-D	Soporte	Supporto	Supporte	Wspornik
40	F330	ø1x10mm	Brass	BF-D	Clavo	Chiodo	Prego	Gwóźdź
2	F348	9mm	Plastic	BF-A	Cornamusas	Galloccia	Cunho	Knaga
8	F371	32mm	Brass	BF-C	Soporte de pasamanos	Supporti per corrimano	Poste de trilho	Poręcz
1	F373	ø15mm	Brass	BF-B	Engranaje	Ingranaggio	Engrenagem	Kolo zębate
2	F374	ø4mm	Brass	BF-C	Carrete	Bobina	Carretel do guincho	Rolek
1	F410	ø2x250mm	Brass	MS	Hilo de latón	Filo in ottone	Fio de latão	Drut
1	F417	ø8x16mm	Brass	BF-B	Motor	Motore	Motor	Silnik



2	F418	ø10x9mm	Brass	BF-B	Linternas	Lanterna di bordo	Luzes	Lampa
2	F419	ø10x3mm	Plastic	BF-A	Linternas	Lanterna di bordo	Luzes	Lampa
4	F420	ø1,5x5mm	Brass	BF-B	Clavijas	Chiodini	Pinos	Pin
1	F422	ø3x118mm	Brass	MS	Eje del timón	Albero di timone	Eixo do leme	Wat
1	F423	ø4x35mm	Brass	BF2	Timón	Timone	Leme	Ster
1	F450	ø8x12mm	Brass	BF-B	Chigre	Verricello, Arganello	Guincho	Wciągaraka
3	F459	ø6x7,5mm	Brass	BF-A, BF-D	Linternas	Lanterna di bordo	Luzes	Lampa
1	F469	ø5x170mm	Brass	MS, BF-C	Je de hélice	Albero porta-elica	Eixo da hélice	Wat napędowy
4	F488	ø3mm	Plastic	BF-A	Bola	Sfera	Esfera	Kula
3	F537	25mm	Brass	BF-C	Cadenote	Lastra cavigliera	Fixador do ovém	Plyta
5	F539	40mm	Brass	BF-B	Cadenote	Lastra cavigliera	Fixador do ovém	Plyta
1	F595	ø6x4mm	Brass	BF-D	Válvula	Valvula	Respiradouro	Wentylacja
2	F626	18mm	Brass	BF-C	Válvula	Valvula	Respiradouro	Wentylacja
16	F627	31mm	Brass	BF-D	SopORTE de pasamanos	Supporti per corrimano	Poste de trilho	Poręcz
1	F629	ø14,5x10mm	Brass	BF-C	Tambor	Tamburo	Tambor	Bęben
2	F637	ø8x12mm	Brass	BF-D	Sirena	Sirena	Sirene	Syrena
1	F643	ø10x9,5mm	Brass	BF-C	Campanilla	Campana	Sino	Dzwon
2	F651	ø7mm	Plastic	BF-A	Volante	Ruota ad uso manuale	Roda manual	Pokręto
6	F655	ø28mm	Rubber	BF-D	Neumático	Pneumatico	Pneu	Opona
2	F658	ø5x6mm	Brass	BF-B	Linternas	Lanterna di bordo	Luzes	Lampa
9	F664	11mm	Brass	BF-C	Cáncamo	Occhio	Olhal	Lampa
1	F677	ø7x5mm	Brass	BF-C	Tambor	Tamburo	Tambor	Śruba oczkowa
3	F717	22mm	Brass	BF-B	Linternas	Lanterna di bordo	Luzes	Bęben
3	F795	200mm	Wire	MS	Manguera	Tubo flessibile	Mangueira	Lampa
1	F804	15x120mm	Rubber	MS	Como de cojin	Parabordo	Defensa	Waż
2	F911-1	ø3x250mm	Alu	MS	Alambre de aluminio	Filo in alluminio	Fio de aluminio	Zdenrzak
1	F958	13x31mm	Resin	BF-A	Motor	Il motore	Motor	Drut Aluminowy
1	F1007	ø30x4,5mm	Wood	BF-A	Volante	Ruota del timone	Volante do timão	Silnik
1	F1014	50mm	Brass	BF-D	Hélice	Elica	Hélice	Kolo sterowe
2	F1016	19mm	Resin	BF-A	SopORTE de hélice	Supporto elica	SupORTE de hélice	Śruba
1	F1017	58mm	Resin	BF-A	Gancho	Gancio	Gancho	Hak
1	F1018	ø4x13mm	Resin	BF-A	Gancho	Gancio	Gancho	Hak
1	F1019	11x14mm	Resin	BF-A	Radar	Radar	Radar	Radar
1	F1020	11mm	Resin	BF-A	Linternas	Lanterna di bordo	Luzes	Lampa

PACKING GROUPS "Found in"





## **Billing Boats**

[www.billingboats.com](http://www.billingboats.com)  
[service@billingboats.dk](mailto:service@billingboats.dk)